

Product data sheet

PPL 2100

Dimensions in mm



Frontal view closed

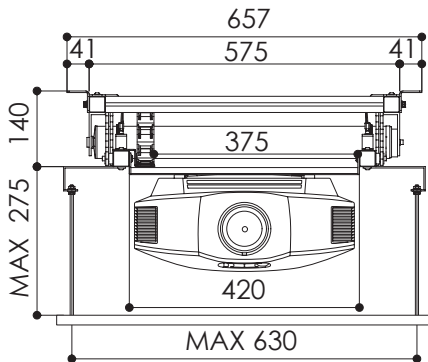

Side view closed

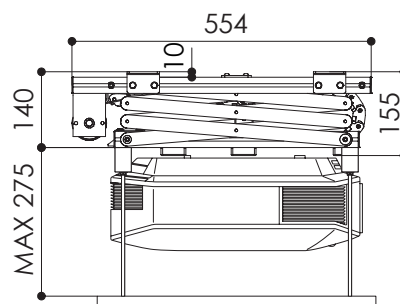

Side view open

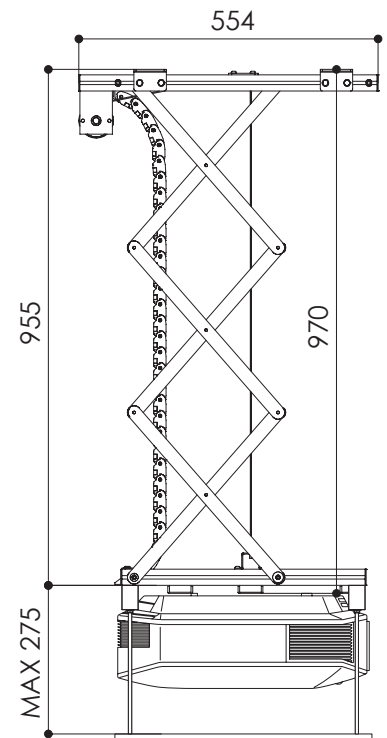

Maximum size fixing points projector

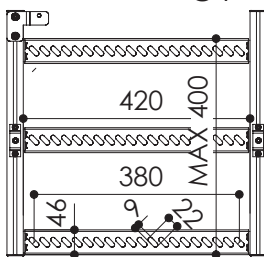

TECHNICAL SPECIFICATIONS

Power supply	220-230 V, 50 Hz
Maximum consumption	184 W
Dimensions lift closed	575 x 155 x 554 mm (WxHxD)
Dimensions lift opened	575 x 970 x 554 mm (WxHxD)
Maximum projector dimensions	570 x 600 mm (WxD)
Maximum size fixing points of the projector	380 x 400 mm (WxD)
Maximum weight	30 kg
Cable management system	Included
Universal projector adapter	
Up/down wall switch	