

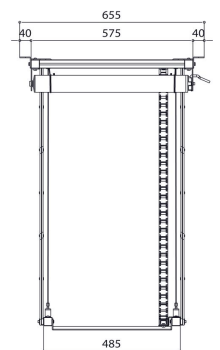

PPL 2100 Projector lift system

The PPL 2100 projector lift system is the perfect solution for the integration of a large and heavy projector into a ceiling where an aesthetical solution is required. Not only is the projector neatly hidden, it is also theft delaying. The lifts runs silently and offers two adjustable positions: top and show.

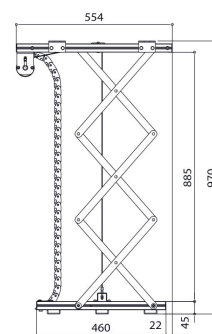

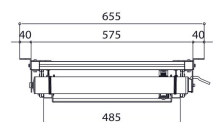
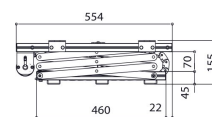
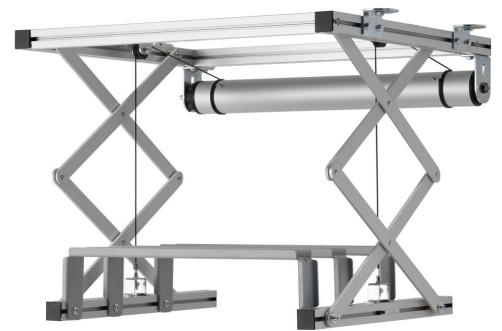
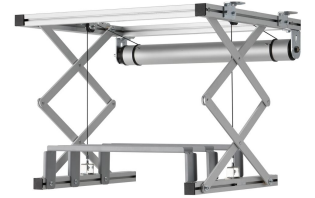

PPL 2100 Projector lift system

Specifications

<i>Article number (SKU)</i>	7021004
<i>Colour</i>	Silver
<i>EAN single box</i>	8712285338380
<i>Width</i>	575
<i>Depth</i>	554
<i>TÜV certified</i>	Yes
<i>Guarantee</i>	2 years
<i>Guarantee electrical parts</i>	2 years
<i>Max. weight load (kg)</i>	30
<i>Average power consumption (W)</i>	184
<i>Certifications</i>	CE
<i>Max. distance to ceiling (mm)</i>	970
<i>Min. distance to ceiling (mm)</i>	155
<i>Voltage</i>	220 V, 50 Hz 230 V, 50 Hz

VOGEL'S HOLDING BV (c)

All rights reserved.
Subject to printing errors,
technical and price
amendments.

Date: 2022-02-11



Vogel's. For Sure.