

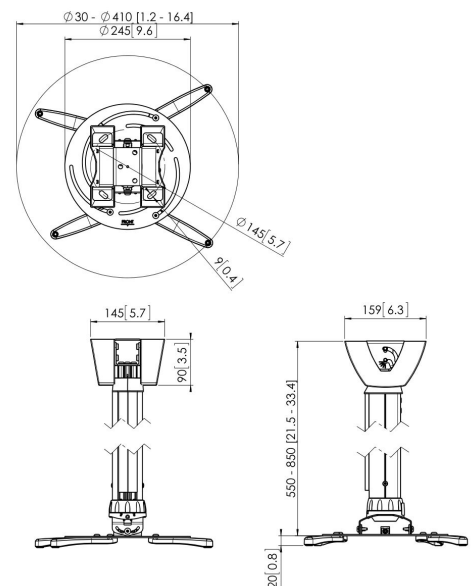

PPC 2555 Projector ceiling mount

The PPC 2555 is a height adjustable projector mount specially designed for the latest generation of projectors weighing up to 30 kg. This projector interface is equipped with fine tune adjustability for precise alignment to the projection surface. Once aligned, the projector stays in position. Turning the unique friction ring will eliminate all play from the interface connections, making the mount a solid and very stable solution.





PPC 2555 Projector ceiling mount



Specifications

Article number (SKU)	7025554
Colour	Silver
EAN single box	8712285325267
TÜV certified	Yes
Tilt	Tilt up to 15°
Turn	Up to 360°
Guarantee	5 years
Max. weight load (kg)	30
Max. distance to ceiling (mm)	850
Min. distance to ceiling (mm)	550
Range (diameter)	30 - 410 mm
Roll	15

VOGEL'S HOLDING BV (c)

All rights reserved.
Subject to printing errors,
technical and price
amendments.

Date: 2022-02-11



Vogel's. For Sure.