

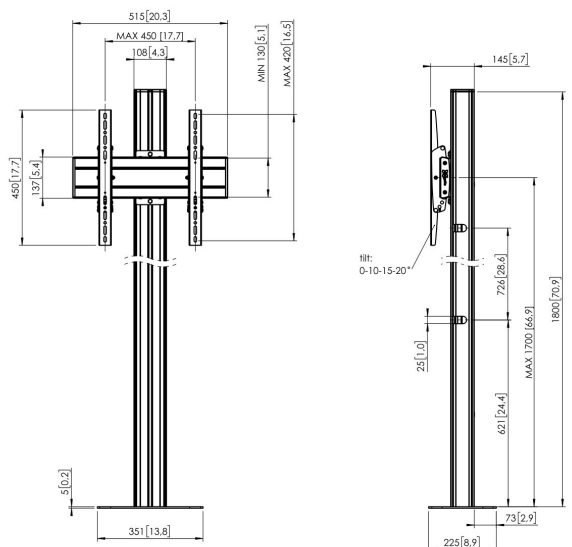

FM1844S Display Floor Stand, fixed to floor (silver)

Floor mounted kit FM1844

Display size: Fitment: 400x400 Max. load: 80 kg - 176 lbs Kit consists of: • 1x PPFF 7060 Floor plate extra large • 1x PUC 2718 pole 180 cm • 1x PFB 3405 Interface bar • 1x PFS 3304 Interface display strips

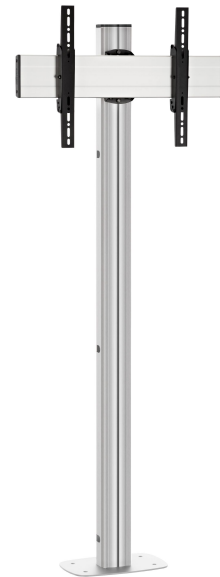



FM1844S Display Floor Stand, fixed to floor (silver)

Specifications

Article number (SKU)	7952024
Colour	Silver
EAN single box	8712285332920
Height	1800
Width	351
Depth	225
TÜV certified	Yes
Tilt	Tilt up to 20°
Guarantee	5 years
Max. weight load (kg)	80
Min. hole pattern	100mm x 100mm
Max. hole pattern	450mm x 420mm
Max. bolt size	M8
Max. height of interface (mm)	450
Max. width of interface (mm)	515
Max. distance to floor - center display (mm)	1700
Max. horizontal hole pattern (mm)	450
Max. screen size (inch)	65
Max. vertical hole pattern (mm)	420
Min. horizontal hole pattern (mm)	100
Min. vertical hole pattern (mm)	100
Universal or fixed hole pattern	Universal

VOGEL'S HOLDING BV (©)

All rights reserved.
Subject to printing errors,
technical and price
amendments.

Date: 2022-06-02



Vogel's. For Sure.