



## CT24222B Ceiling mount turn

Article number (SKU)  
Colour

7955070  
Black

### Key Benefits

- Stylish high-end design
- Easy install
- Rotatable

### Ceiling mount kit CT24222

Display size: Fitment: 200x200Max. load: 30 kg - 66 lbs Kit consists of: • 1x PUC 1045 Ceiling plate turn and tilt • 1x PUC 2422 Pole 220 cm • 1x PFI 3045 Display interface

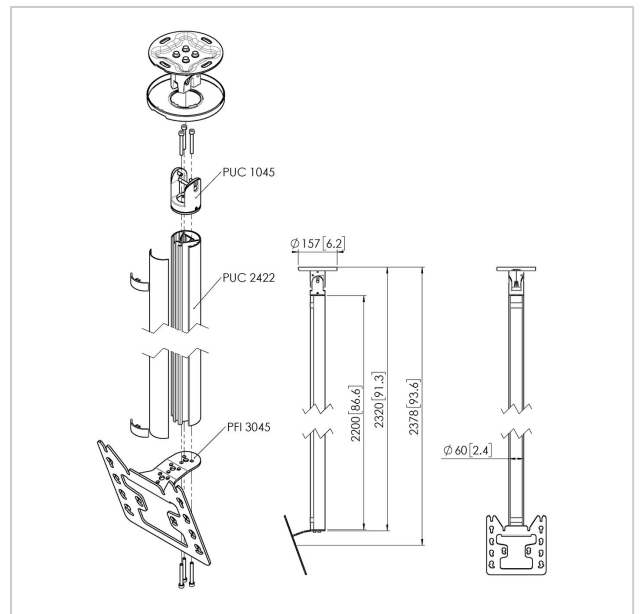



## CT242222B Ceiling mount turn

[www.vogels.com](http://www.vogels.com)

VOGEL'S HOLDING BV 2019 (c) All rights reserved.  
Subject to printing errors, technical and price amendments.  
Date:2021-08-23

### Specifications

Product type number	CT242222	Min. horizontal hole pattern (mm)	100
Article number (SKU)	7955070	Min. screen size (inch)	19
Colour	Black	Min. vertical hole pattern (mm)	100
EAN single box	8712285347085	Orientation	Landscape / Portrait
Length	2503	Universal or fixed hole pattern	Fixed
Width	130		
Depth	450		
TÜV certified	Yes		
Tilt	Tilt up to 20°		
Turn	Up to 360°		
Guarantee	5 years		
Max. weight load (kg)	30		
Max. bolt size	M8		
Max. height of interface (mm)	253		
Max. width of interface (mm)	240		
Ceiling types	Flat / inclined ceiling		
Height options	Fixed height		
Levelling function	Post-installation horizontal levelling		
Max. distance to ceiling - center display (mm)	2378		
Max. horizontal hole pattern (mm)	200		
Max. screen size (inch)	43		
Max. vertical hole pattern (mm)	200		