



PRODUCT TECHNICAL SHEET[®]

ACOUSTIC PARQUET

acoustic tiles
patented design

EN Acoustic Parquet is the redefinition of a classic element of architectural cladding. Since acoustic correction often requires the installation of sound absorbing coverings for wall and ceiling, we have drawn inspiration from the existing material and cladding techniques, and we have adopted their shape and installation procedures. We want to be able and free to perform creative applications both in small and large areas, keeping the process simple and orderly at the same time.

IT Acoustic Parquet è la ridefinizione di un elemento classico del rivestimento in architettura. Visto che la correzione acustica spesso prevede il rivestimento a parete e soffitto di elementi fonoassorbenti abbiamo tratto ispirazione da quanto finora esiste come rivestimento, riprendendone la forma e lo schema di posa. Questo perché ci piaceva l'idea di poter essere liberi di creare applicazioni di aree sia piccole che grandi con una certa creatività e anche in maniera davvero semplice ma ordinata allo stesso tempo.

FR « Parquet acoustique » est la redéfinition d'un élément classique dans le revêtement architectural. Du moment où la correction acoustique prévoit souvent un revêtement mural et des éléments insonorisant, nous nous sommes inspirés aux revêtements existants jusqu'à présent, reprenant la forme et la disposition de l'installation. Nous souhaitons favoriser la création libre d'applications aussi bien pour une petite zone que pour une grande, avec une certaine créativité, mais aussi de manière très simple et ordonnée à la fois.

DE Acoustic Parquet ist die Neudefinition eines klassischen Elements der Beschichtungsarchitektur. Da für Schalldämpfung oft Verkleidungen für Wand und Decke angebracht werden müssen, haben wir uns von den vorhandenen Material- und Verkleidungstechniken inspirieren lassen und deren Form und Einbauverfahren übernommen. Wir möchten in der Lage sein, kreative Anwendungen sowohl in kleinen als auch in großen Bereichen auszuführen, wobei der Prozess gleichzeitig einfach und ordentlich sein soll.

EN Mounting systems - **IT** Sistemi di fissaggio
FR Systèmes de fixation - **DE** Montagesysteme



GLUE
CEILING
AND WALL

ATTENTION: TOLERANCE

EN The dimensions shown in the drawings are subject to tolerances of ± 2 mm.

IT Le quote riportate nei disegni sono soggette a tolleranze di ± 2 mm.

FR Les dimensions indiquées sur les dessins sont soumises une tolérance de ± 2 mm.

DE Die in den Zeichnungen angegebenen Abmessungen unterliegen eine Toleranz von ± 2 mm.

Version: 1.0

EN Sizes - **IT** *Formati* - **FR** *Formats* - **DE** *Formate*
depth 3 cm and 4 cm

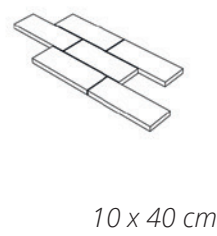
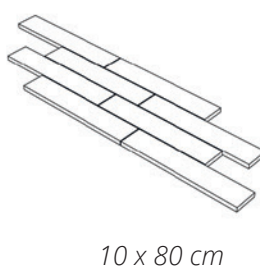
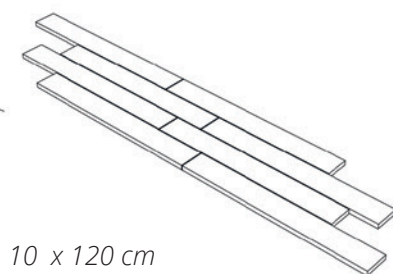
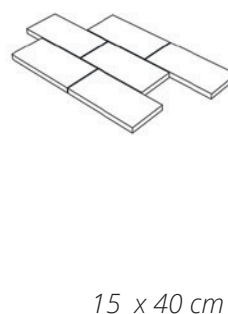
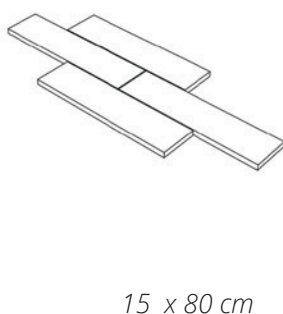
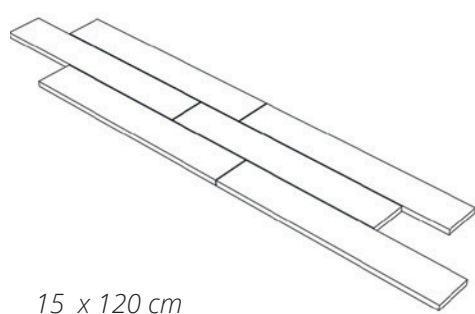
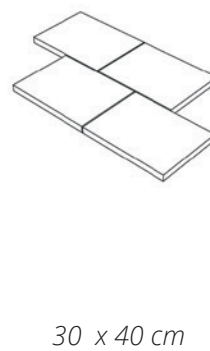
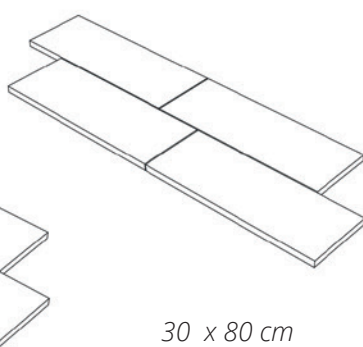
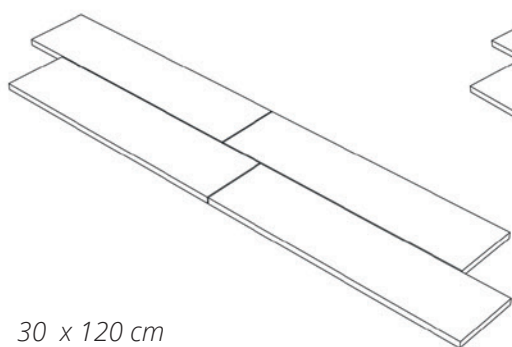

EN Mounting systems - **IT** *Sistemi di fissaggio* - **FR** *Systèmes de fixation* - **DE** *Montagesysteme*

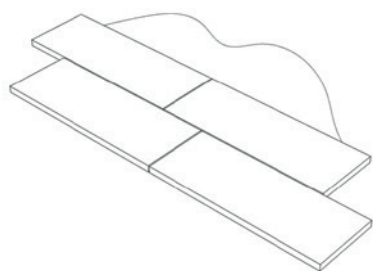

EN Glue mounting
IT *Fissaggio a colla*
FR *Fixation par colle*
DE *Leimverlegung*
(to wall and ceiling- a parete e soffitto mur et plafond - an die Wand und Decke)

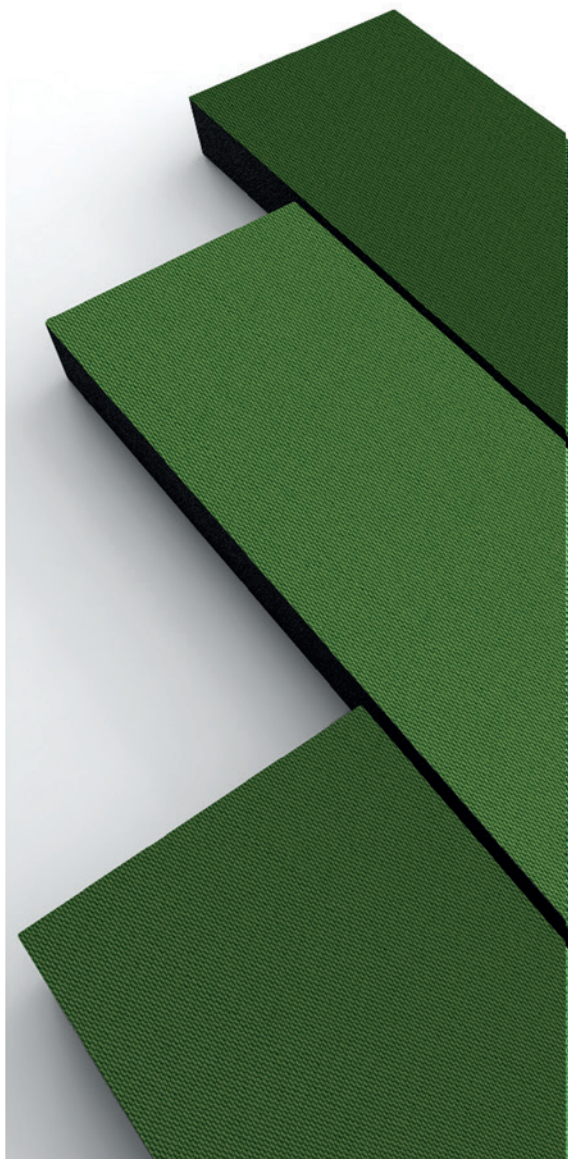

Finish fabric ECO

Colours - *Colori* - Couleurs - *Farbe* p. 6



Finish Materica™

Colours - *Colori* - Couleurs - *Farbe* p. 5

ATTENTION!

EN Handle the panels with great care. Try to avoid lifting the panels only on one side and crushing them, in order to prevent possible damage or creases that could be visible once the panels are installed.

IT Manipolare i pannelli con molta cura cercando di evitare di sollevarli solamente da un lato e di schiacciarli, per non creare possibili danni o pieghe che potrebbero risultare visibili una volta installati.

FR Manipulez les panneaux avec le plus grand soin, en essayant d'éviter de les soulever d'un seul côté et de les écraser, afin de ne pas créer d'éventuels dommages ou plis qui pourraient être visibles une fois les panneaux installés.

DE Behandeln Sie die Paneele mit großer Sorgfalt. Vermeiden Sie es, die Paneele nur auf einer Seite anzuheben und zu quetschen, um mögliche Schäden oder Falten zu vermeiden, die nach dem Einbau der Paneele sichtbar werden könnten.



EN Fire reaction of components - IT Reazione al fuoco dei componenti FR Réaction au feu des composants - DE Reaktion auf das Feuer der Bauteile

Polyester fiber - Fibra di poliestere
Fibre di polyester - Polyesterfaser
Thickness 4 cm - Spessore 4 cm
Épaisseur 4 cm - Dicke 4 cm

Euroclass - Euroclasse
Classe européenne - Euroklasse
B, s2-d0

Fabric- Tessuto - Tissus - Gewebe
ECO

FLAMMABILITY: EN1021/1-2 CRIB 5 BS 7176 Medium Hazard California
TB117 UNI 9175 Class 1 | M

EN Cleaning - IT Pulizia - FR Nettoyage - DE Reinigung

EN Remove liquids and/or stains immediately with paper towels or a dry cloth without exerting pressure on the surface. In case of stain penetration, rub gently with a soft and damp sponge. If necessary, use neutral soap and rinse it thoroughly with a soft, clean sponge moistened with lukewarm water.

IT Asportare immediatamente i liquidi e/o le macchie con carta assorbente o panno asciutto senza esercitare pressione sulla superficie. In caso di penetrazione della macchia, strofinare delicatamente con spugna morbida e umida. Se necessario usare del sapone neutro da risciacquare abbondantemente con una spugna morbida, pulita e inumidita di acqua tiepida.

FR Enlevez immédiatement les liquides et/ou les taches avec du papier absorbant ou un chiffon sec sans exercer de pression sur la surface. En cas de pénétration de taches, frottez doucement avec une éponge douce et humide. Si nécessaire, utilisez un savon neutre en le rinçant bien avec une éponge douce et propre humidifiée avec de l'eau tiède.

DE Flüssigkeiten und/oder Flecken sofort mit einem Papiertuch oder einem trockenen Tuch entfernen und keinen Druck auf die Fläche ausüben. Mit einem weichen und feuchten Schwamm vorsichtig abreiben, falls der Fleck durchdringt. Wenn nötig, neutrale Seife benutzen und sie dann mit einem weichen und sauberen Schwamm spülen, der früher mit lauwarmem Wasser angefeuchtet wurde.

EN Acoustic Properties - IT Proprietà acustiche FR Propriétés acoustiques - DE Akustische Eigenschaften

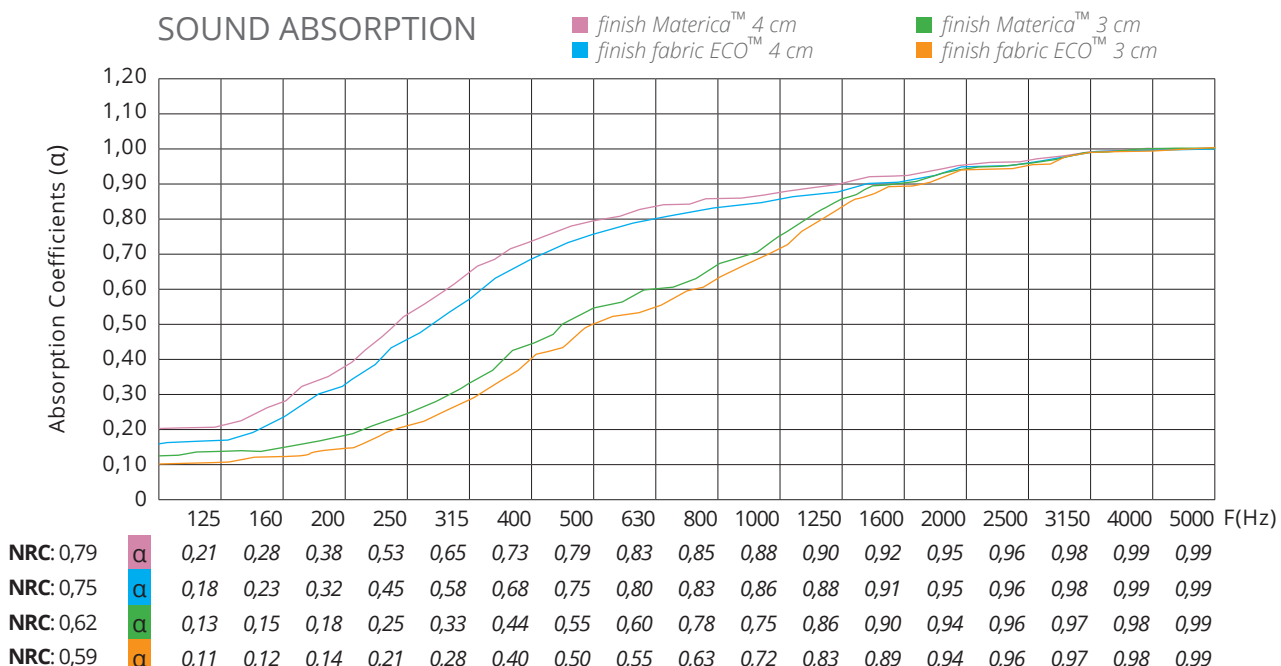

Materica™

patented design

MatericaWALL®

Gray Shades
on White fiber



MC31

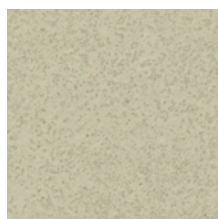

MC32

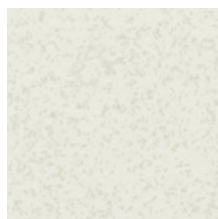

MC33

MatericaWALL®

Colour Shades
on White fiber

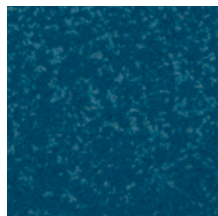

MC51



MC52

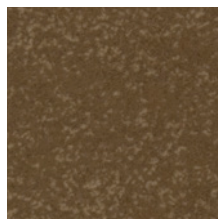

MC53



MC54

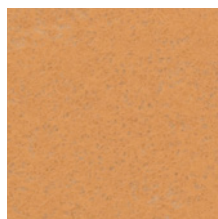

MC55



MC56

MatericaCEMENT®

Gray Shades
on Black fiber

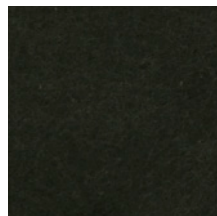

MC11

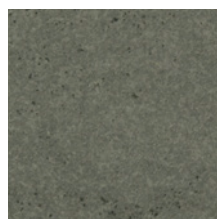

MC12



MC13



MC14

Custom colours



MC
on white fiber or
black fiber

EN In addition to the colours available, it is possible to request custom colours. The colours shown are purely indicative.

IT Oltre alle colorazioni disponibili è possibile produrre colorazioni su richiesta. I colori riportati sono indicativi.

FR En plus des couleurs disponibles, il est possible de demander des couleurs personnalisés. Les couleurs présentées sont indicatives.

DE Zusätzlich zu den verfügbaren Farben ist es möglich, auf Anfrage Farben herzustellen. Die angeführten Farben gelten lediglich als Beispiel.

ECO fabric - *tessuto* - *tissus* - *Gewebe*

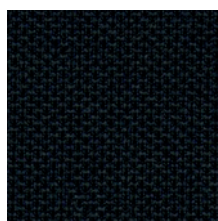

TE01



TE27

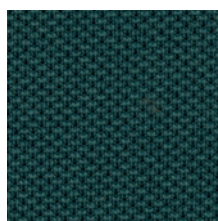

TE15

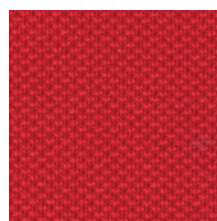

TE39

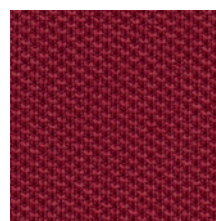

TE35

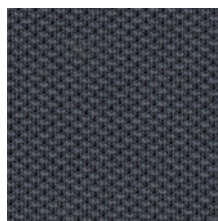

TE02



TE24

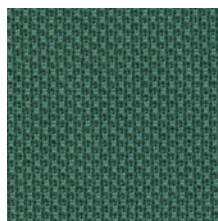

TE11

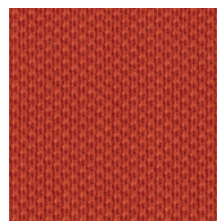

TE32

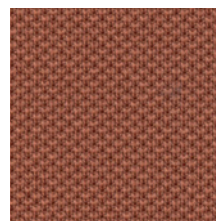

TE34

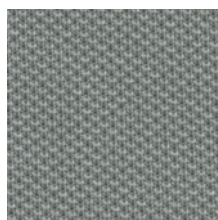

TE04



TE23

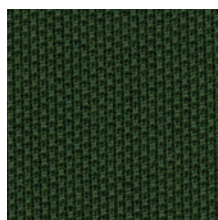

TE08

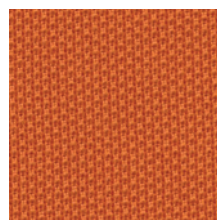

TE31

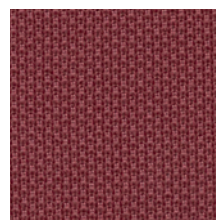

TE36

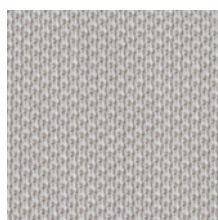

TE06

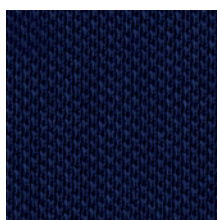

TE21

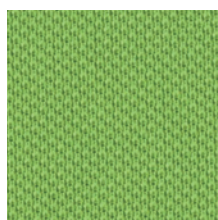

TE10

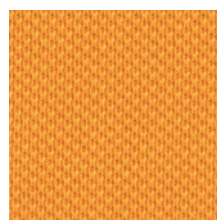

TE29

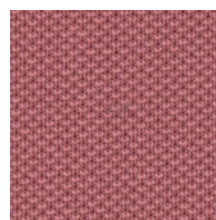

TE37

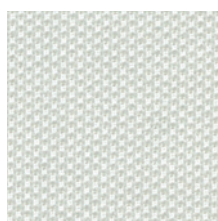

TE07

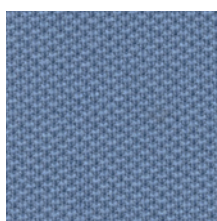

TE19

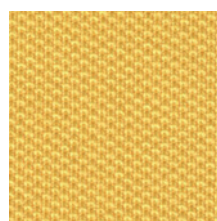

TE28

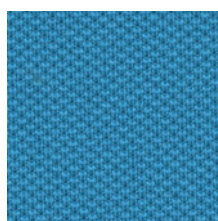

TE17

EN - The colours shown are purely indicative.
 IT - I colori riportati sono indicativi.
 FR - Les couleurs présentées sont indicatives.
 DE - Die angeführten Farben gelten lediglich als Beispiel.

COMPOSITION: 100% Recycled Polyester
ABRASION RESISTANCE: UNI ISO 12947/2
 100.000
FLAMMABILITY: EN1021/1-2 CRIB 5 BS
 7176 Medium Hazard California TB117 UNI
 9175 Class 1|M
OEKO-TEX STANDARD 100



Follow us on:



ACOUSTIC PARQUET® **MADE IN ITALY** 3+1+1 YEAR WARRANTY