

ESF655P

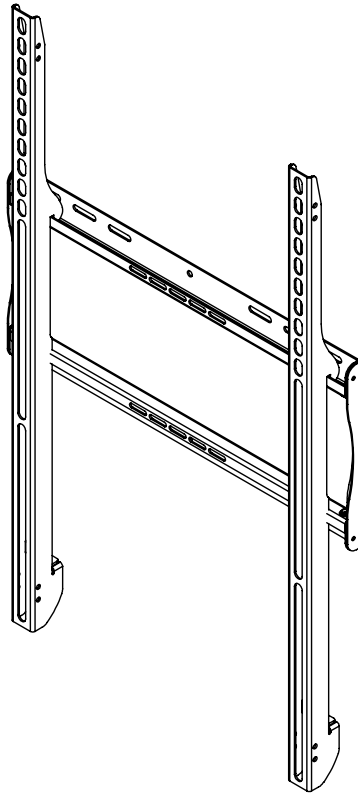
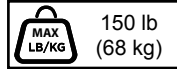

▲ WARNING

ENG - This product is designed to be installed on wood stud, solid concrete or cinder block walls. Hardware is included for wood stud, solid concrete and cinder block installation. Before installing make sure the supporting surface will support the combined load of the equipment and hardware. Screws must be tightly secured. Do not overtighten screws or damage can occur and product may fail. Never exceed the Maximum Load Capacity. Always use an assistant or mechanical lifting equipment to safely lift and position equipment. Be careful not to pinch fingers when operating the mount. For support please call customer care at 1-800-865-2112.

ENG Tools Needed for Assembly.

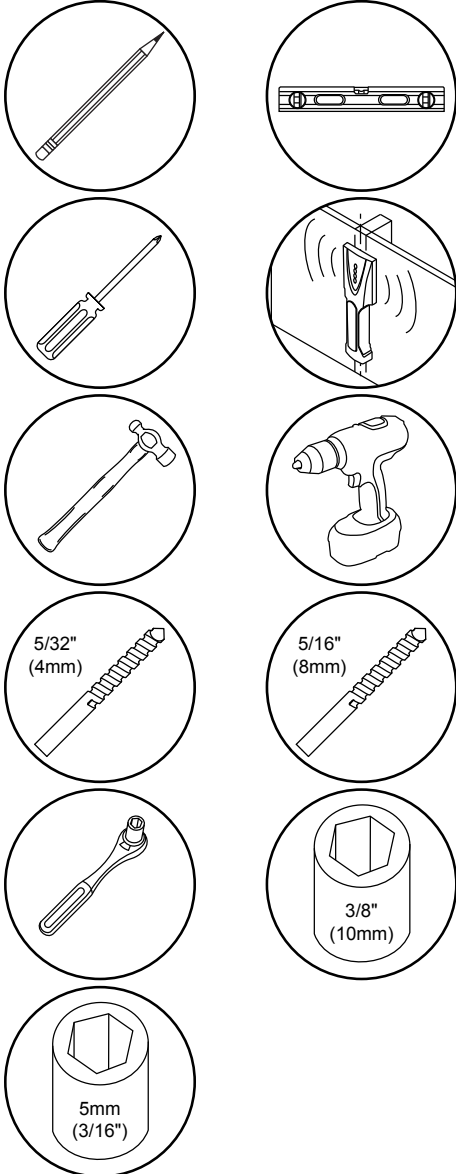

ENG Symbols

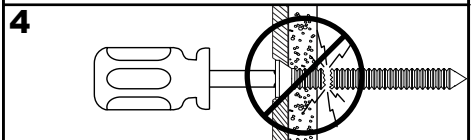
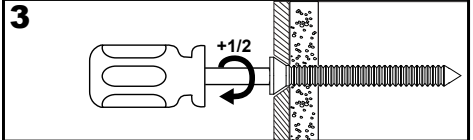
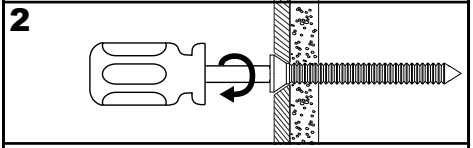
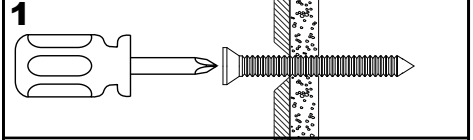
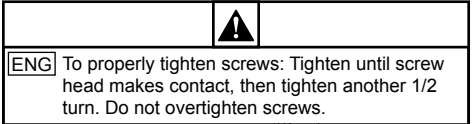
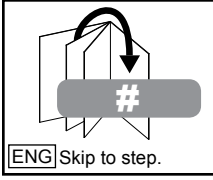
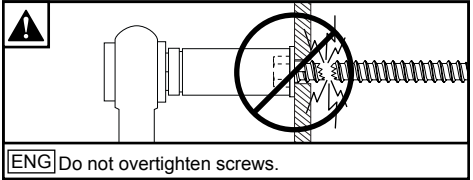
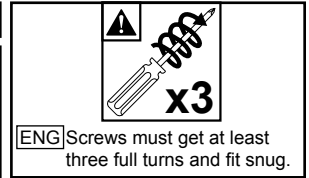

ENG Parts (Before beginning, make sure you have all parts shown below).

Parts List		ESF655P
Description	Qty	Part #
A wall plate	1	201-T5946
B adapter bracket	2	200-T5946
C 4mm allen wrench	1	560-1727
D concrete anchor	4	590-0320
E #14 x 2.5" wood screw	4	520-D1033
F M8 x 25mm	4	520-5027
G washer	4	540-D9406
H spacer	4	540-1059

G (4)
washer

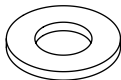

H (4)
spacer

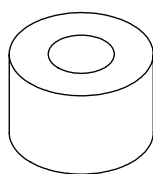

A (1)
wall plate

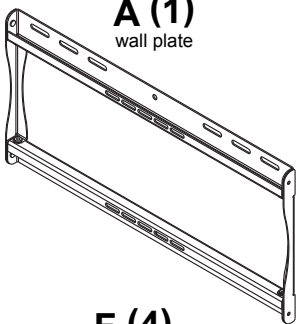

B (2)
adapter bracket

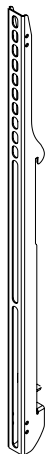

C (1)
allen wrench



D (4)

8mm concrete anchor

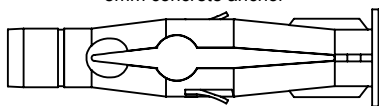

F (4)

M8 x 25mm



E (4)

#14 x 2-1/2" wood screw

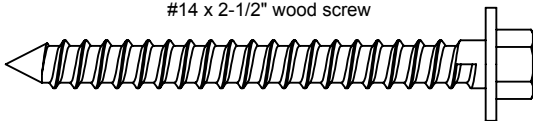

1

ENG Wood stud wall.

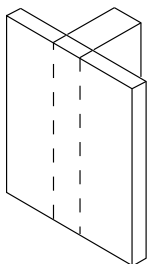

1a

ENG Concrete/Cinder block.

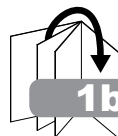
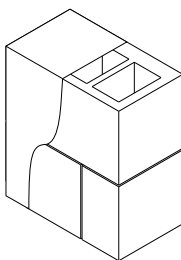

1b

1a

▲ WARNING

ENG - When installing Peerless wall mounts on a wood stud wall covered with gypsum board (drywall), verify that the wood studs are a minimum of 2" x 4" nominal size. Do not install over gypsum board thicker than 5/8".

1a-1

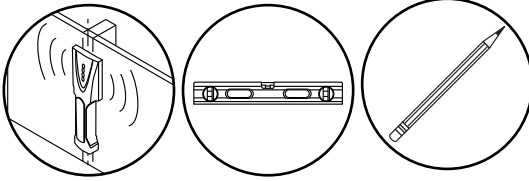

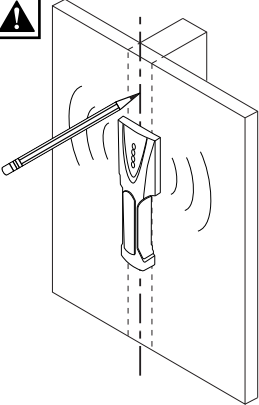
  **ENG** Use stud finder to locate and mark stud center lines.

1a-2

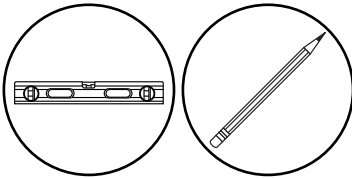

ENG Level wallplate. Mark mounting holes on stud center lines.

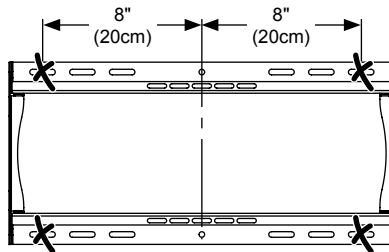
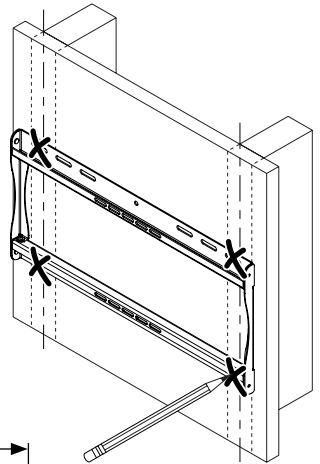

1a-3

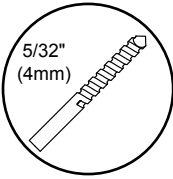

ENG Drill mounting holes into supporting surface (2.5" (64mm) minimum depth required).

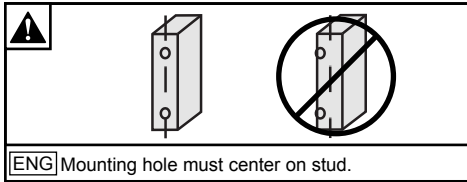
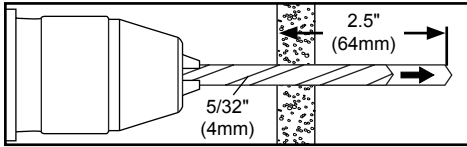

ENG Mounting hole must center on stud.

1a-4

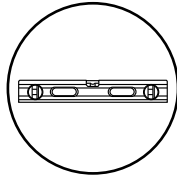
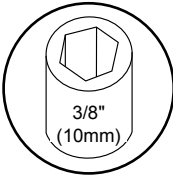
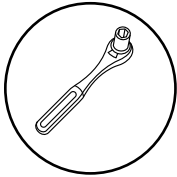

ENG Level wallplate. Install using wood screws provided.

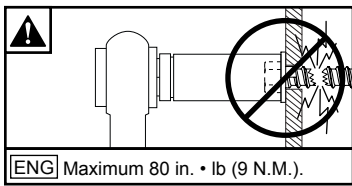

ENG Maximum 80 in. • lb (9 N.M.).

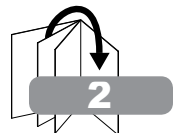
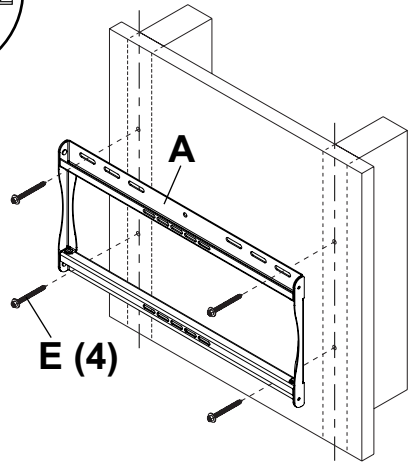

1b

▲ WARNING

ENG - When installing Peerless wall mounts on a concrete wall, the wall must be at least 8" thick with a minimum compressive strength of 2000 psi. When installing Peerless wall mounts on a cinder block wall, the cinder blocks must meet ASTM C-90 specifications and have a minimum nominal width of 8". Do not drill into mortar joints! Be sure to mount in a solid part of the block, generally 1" (25 mm) minimum from the side of the block. It is suggested that a standard electric drill on slow setting is used to drill the hole instead of a hammer drill to avoid breaking out the back of the hole when entering a void or cavity. Never attach concrete expansion anchors to concrete or cinder block covered with plaster, drywall or other finishing material.

1b-1

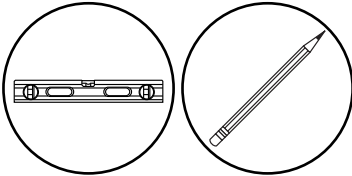

ENG Level wallplate. Mark mounting holes.

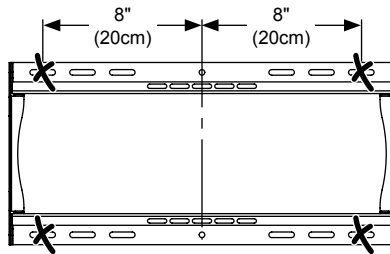
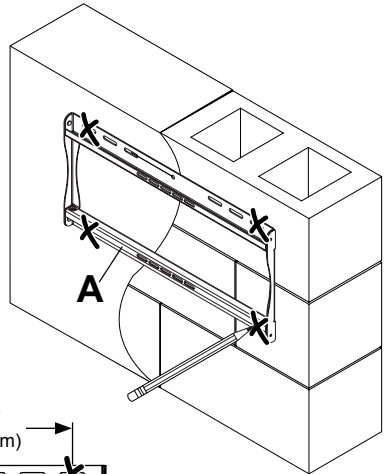

1b-2

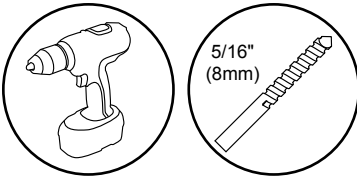

ENG Drill mounting holes into supporting surface (2.5" (64mm) minimum depth required).

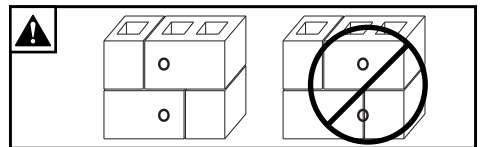
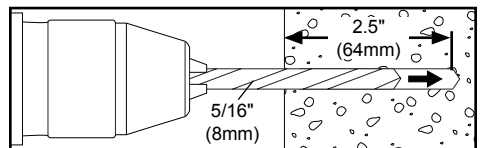

ENG Do not drill into mortar joints.

1b-3

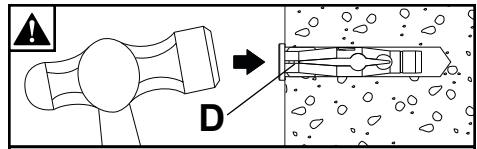
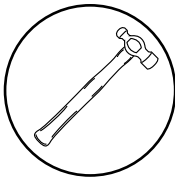

ENG Insert anchor flush to concrete.

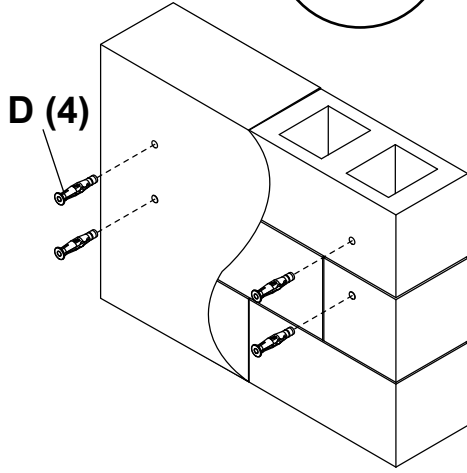

1b-4

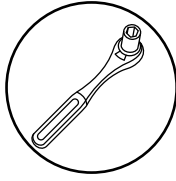
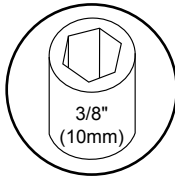
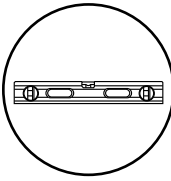

ENG Level wallplate. Install using concrete anchors and wood screws provided.

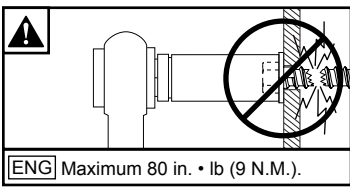

ENG Maximum 80 in. • lb (9 N.M.).

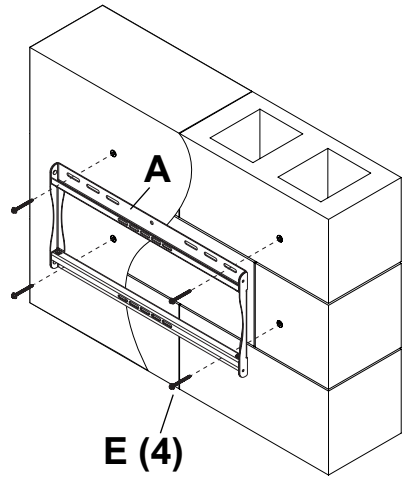

2

ENG Center adaptor brackets vertically on back of screen.

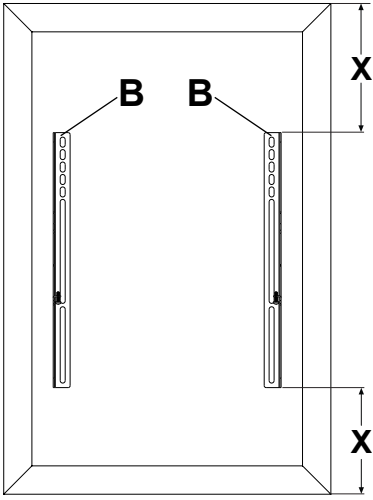

3

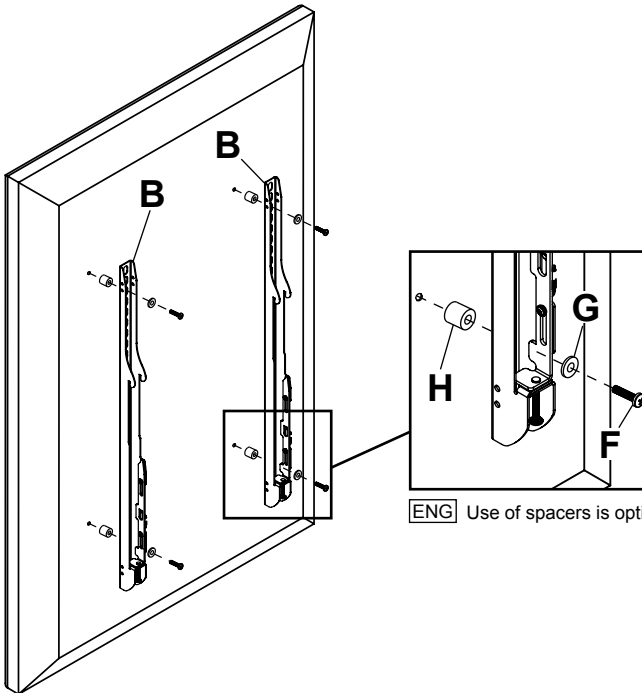

ENG Use of spacers is optional.

4

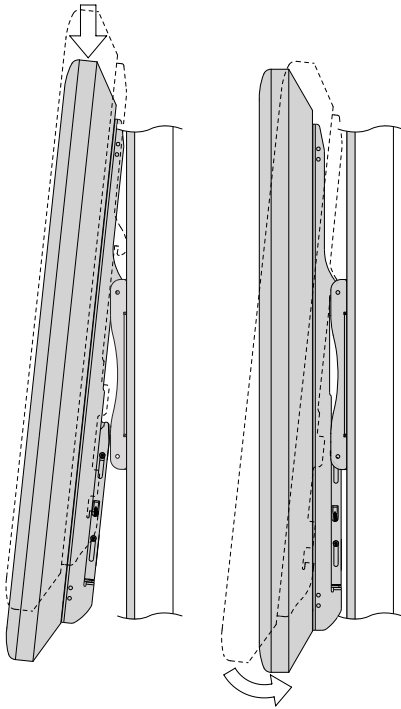

5

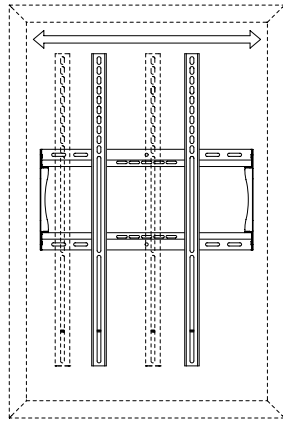

6

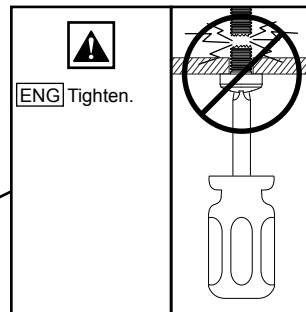
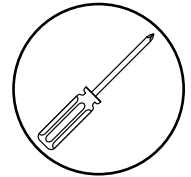
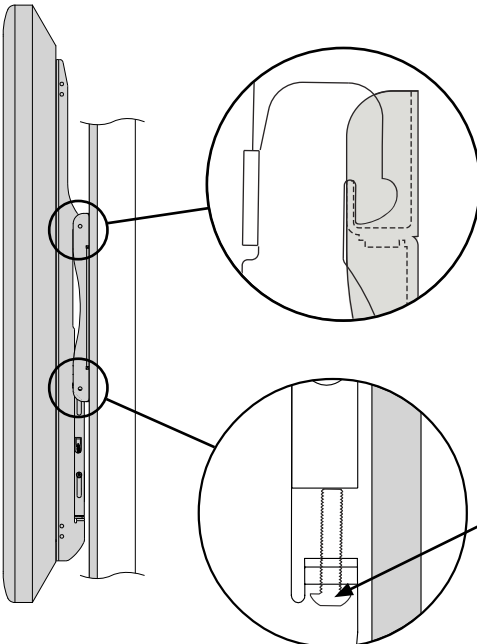

ENG	This page intentionally left blank.
ESP	Página en blanco.
FRN	Cette page a été laissée en blanc intentionnellement.
DEU	Diese Seite wurde absichtlich freigelassen.
NEL	Deze pagina is met opzet blanco gelaten.
ITL	Pagina lasciata intenzionalmente vuota.
ČES	Tato strana je záměrně prázdná.
SLK	Táto strana je zámerne prázdna.
POR	Esta página foi intencionalmente deixada em branco.
TÜR	Bu sayfa özellikle boş bırakılmıştır.

LIMITED FIVE-YEAR WARRANTY

Peerless Industries, Inc. ("Peerless") warrants to original end-users of Peerless® products will be free from defects in material and workmanship, under normal use, for a period of five years from the date of purchase by the original end-user (but in no case longer than six years after the date of the product's manufacture). At its option, Peerless will repair or replace, or refund the purchase price of, any product which fails to conform with this warranty.

In no event shall the duration of any implied warranty of merchantability or fitness for a particular purpose be longer than the period of the applicable express warranty set forth above. Some states do not allow limitations on how long a implied warranty lasts, so the above limitation may not apply to you.

This warranty does not cover damage caused by (a) service or repairs by the customer or a person who is not authorized for such service or repairs by Peerless, (b) the failure to utilize proper packing when returning the product, (c) incorrect installation or the failure to follow Peerless' instructions or warnings when installing, using or storing the product, or (d) misuse or accident, in transit or otherwise, including in cases of third party actions and force majeure.

In no event shall Peerless be liable for incidental or consequential damages or damages arising from the theft of any product, whether or not secured by a security device which may be included with the Peerless® product. Some states do not allow the exclusion or limitation of incidental or consequential damages, so the above limitation or exclusion may not apply to you.

This warranty is in lieu of all other warranties, expressed or implied, and is the sole remedy with respect to product defects. No dealer, distributor, installer or other person is authorized to modify or extend this Limited Warranty or impose any obligation on Peerless in connection with the sale of any Peerless® product.

This warranty gives specific legal rights, and you may also have other rights which vary from state to state.



Peerless-AV

2300 White Oak Circle
Aurora, IL 60502
Email: tech@peerlessmounts.com
Ph: (800) 865-2112
Fax: (800) 359-6500
www.peerless-av.com

© 2017, Peerless Industries, Inc.

Peerless-AV Europe

Unit 3 Watford Interchange,
Colonial Way, Watford, Herts,
WD24 4WP, United Kingdom
Customer Care
44 (0) 1923 200 100
www.peerless-av.com

© 2017, Peerless Industries, Inc.

Peerless-AV de Mexico

Ave de las Industrias 413
Parque Industrial Escobedo
Escobedo N.L Mexico 66050
Servicio al Cliente
01-800-849-65-77
www.peerless-av.com

© 2017, Peerless Industries, Inc.