



Lodo Evolution

Posizionare l'imballo all'interno della sala di installazione assicurandosi di preparare lo schermo con il verso nella giusta direzione.
Place the empty packaging in the installation room making sure that the screen is positioned with its front side in the right direction.



Disimballare lo schermo.
Unpackaged the screen.



- !** L'installazione deve essere eseguita da personale esperto: la squadra competente dovrà occuparsi dello scarico, del sollevamento, dell'ancoraggio e del collegamento elettrico.
The installation must be carried out by qualified staff: the team in charge will have to unload, hoist and anchor the screen and connect the wiring.
- !** ! L'installazione del sistema non corretto può danneggiare il motore e il sistema di controllo. La mancata osservanza delle istruzioni di installazione farà decadere ogni garanzia!
! The improper installation of the system may damage the motor and the control system. The installation not in compliance with the given instructions will nullify the warranty!
- !** DURANTE LA MANOVRA DI SOLLEVAMENTO È ASSOLUTAMENTE VIETATO PER CHIUNQUE OCCUPARE O TRANSITARE NELL'AREA SOTTOSTANTE LO SCHERMO. QUALSIASI ERRORE NEL MONTAGGIO DEL SISTEMA DI SOLLEVAMENTO POTREBBE AVERE CONSEGUENZE FATALI!
DURING THE HOISTING PROCESS IT IS STRICTLY FORBIDDEN TO WALK IN THE AREA UNDERNEATH THE SCREEN. ANY MISTAKE IN THE INSTALLATION OF THE SYSTEM COULD BE FATAL!
- !** Tutte le procedure di installazione non conformi o che differiscono dalle metodologie descritte nel presente manuale non saranno coperte da garanzia.
Any divergence from the procedures laid out in this manual will not be covered by the warranty.



Installazione staffe
Brackets installation

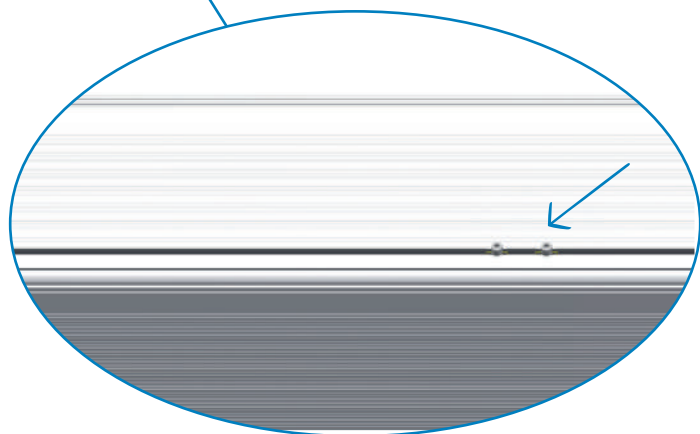
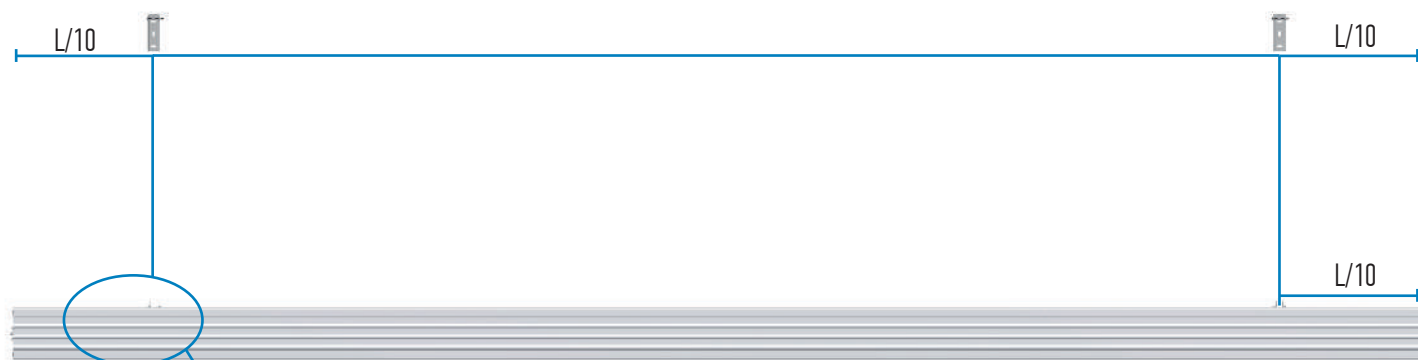

Installa le staffe a muro secondo l'indicazione L/10.
Sullo schermo troverai le viti nella posizione corretta L/10.
Applica nella stessa posizione la parte di staffa da installare
allo schermo.

Install brackets according to the indication L/10.
The screws will be already in the correct position L/10.
Install the part of the bracket that must be installed on the
screen in the same position of the screws.

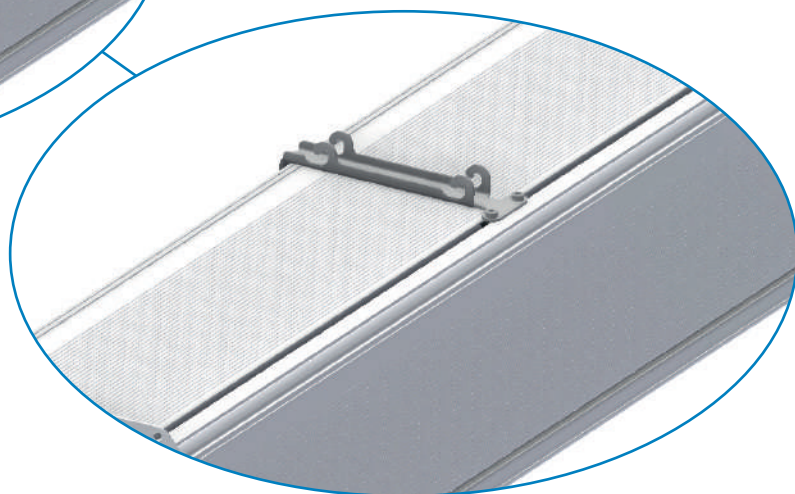
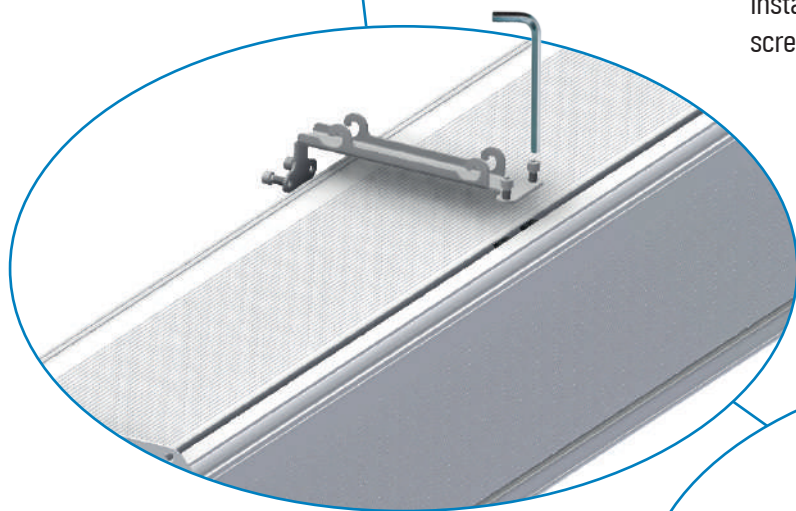

Installazione staffe a parete
Wall brackets installation

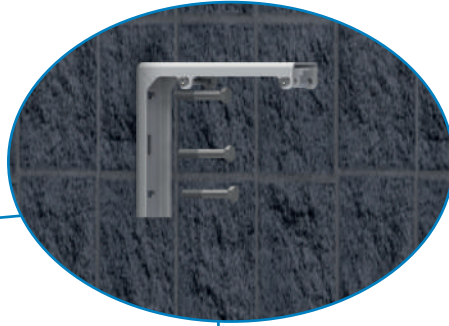
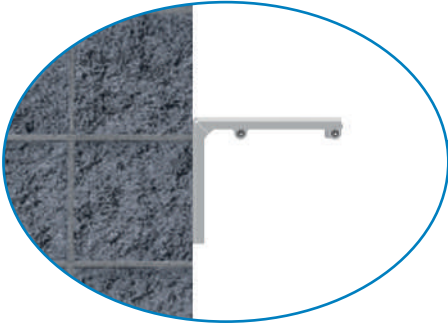

Installazione staffe a soffitto
Ceil brackets installation

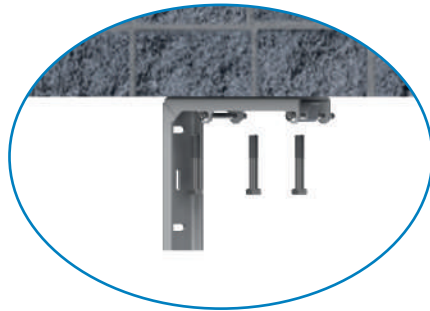

Installazione schermo
Screen installation

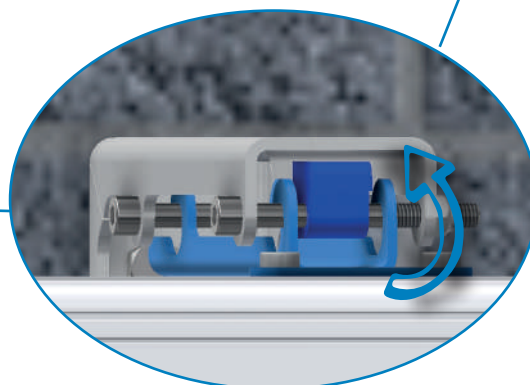
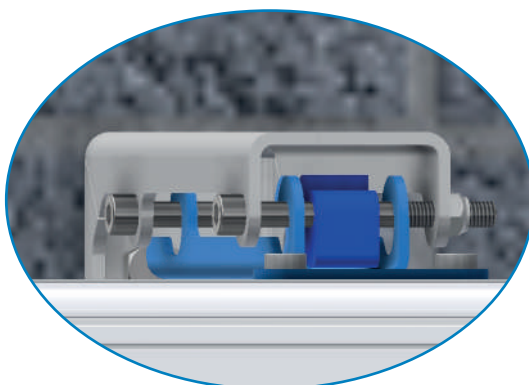
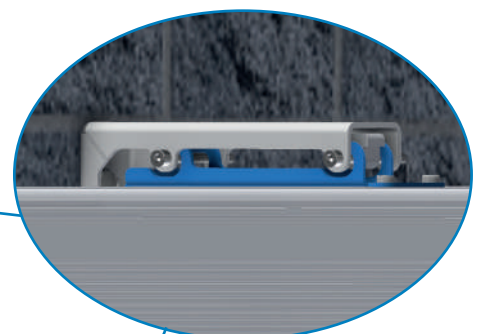
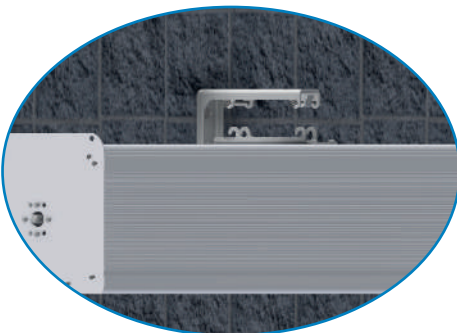

Ruotare il gancio
per chiudere la staffa

Rotate the hook
to lock the bracket

Installazione catena di sicurezza
Wall safety chains

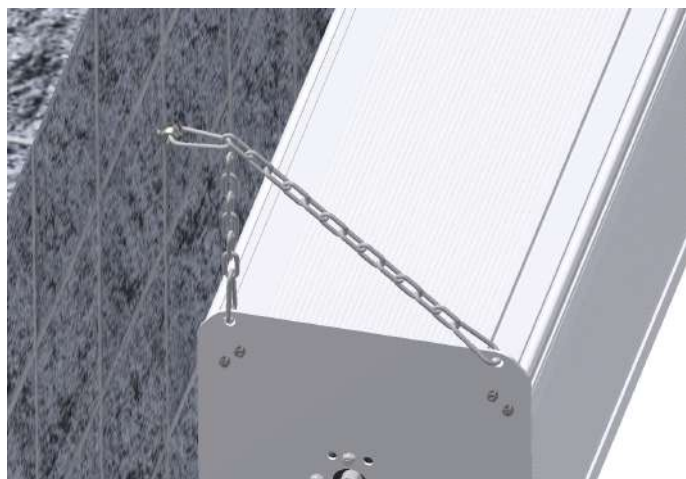
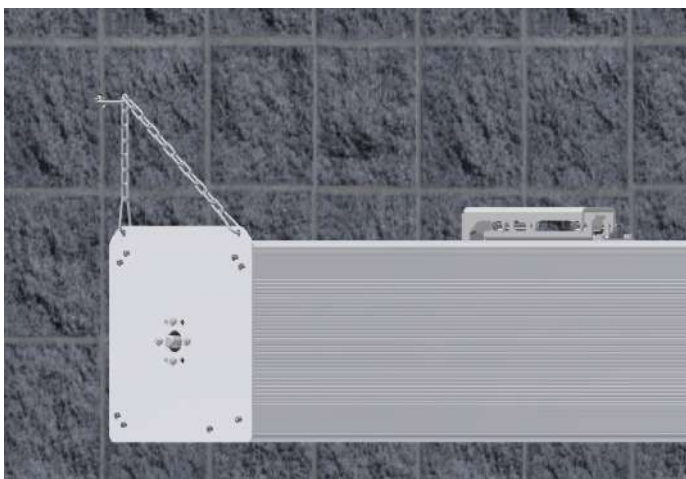

Regolazione contrappeso per flettere la tela dello schermro . Solo in caso di pieghe.
Regulation of the counterweight in order to flat the fabric. Just in case of waves.

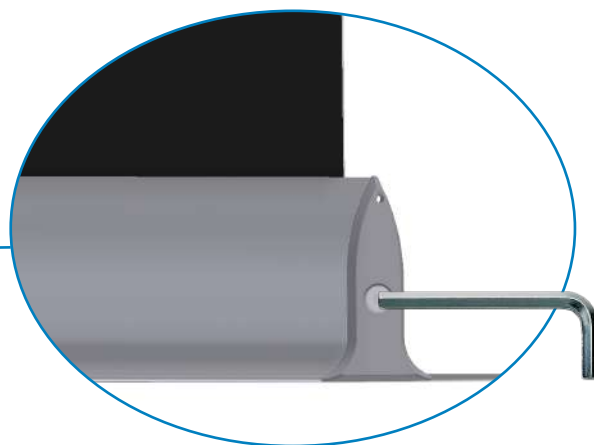
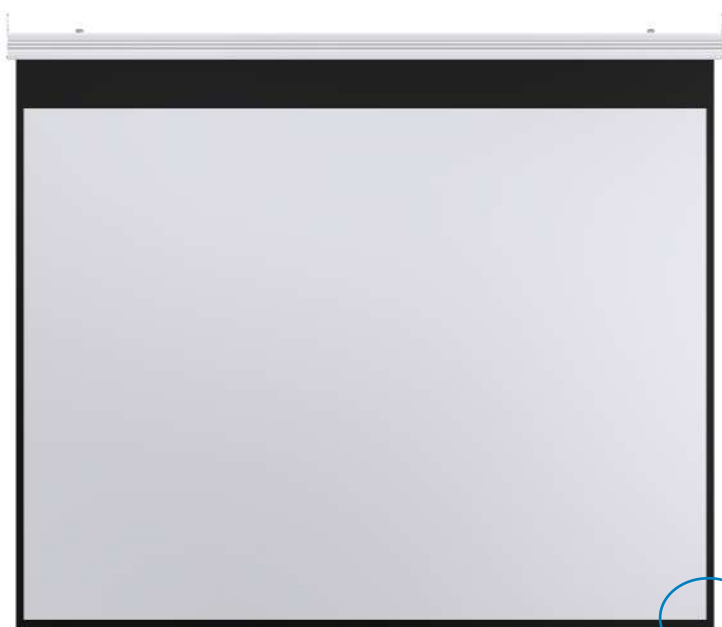

ATTENZIONE / WARNING!

La tela in PVC è molto sensibile al calore. In un ambiente molto caldo la tela può ammorbidirsi eccessivamente ed allungarsi verso il basso alterando il rapporto video. Si deve evitare assolutamente di posizionare lo schermo davanti a finestre illuminate dal sole oppure sopra termosifoni, caminetti e stufe di ogni genere. Maggiore sarà il calore assorbito dallo schermo, maggiore sarà la deformazione del telo che assumerà una forma allungata con i bordi laterali incurvati.

The PVC fabric is very sensitive to heating. In a very hot environment the fabric can soften excessively and stretch down by altering the video ratio. You should absolutely avoid placing the screen in front of sunlit windows or above radiators, fireplaces and stoves of all kinds.

The higher will be the heating absorbed by the screen, the higher will be the deformation of the surface which will assume an elongated shape with curved lateral edges.

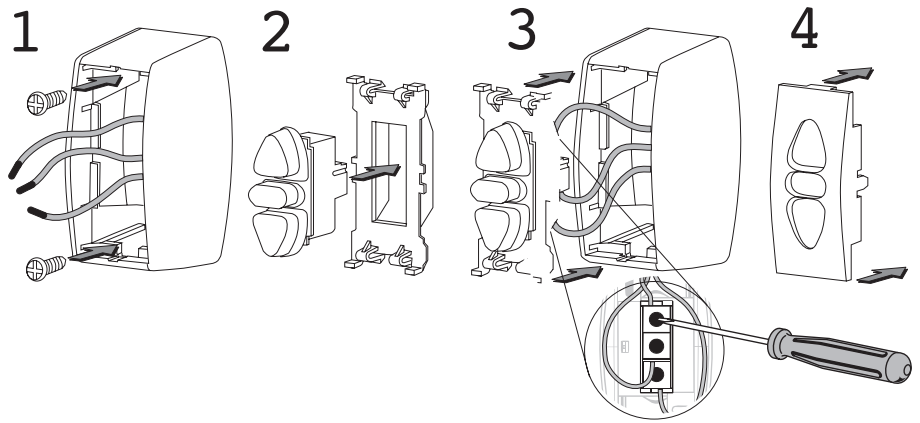
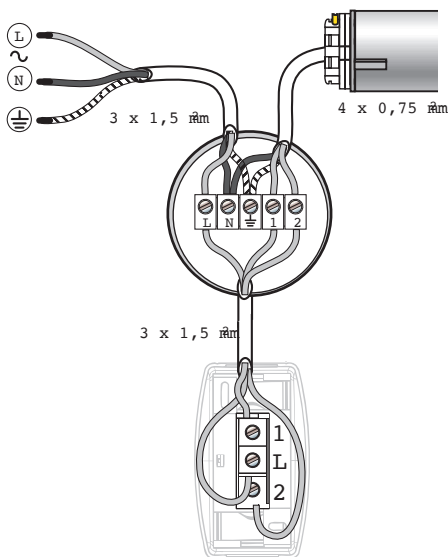

ITALIANO

MORSETTI	ALIMENTAZIONE	MOTORE (EUR)	MOTORE (US)
L	FASE (L)		
N	NEUTRO (N)	BLU	BIANCO
W	TERRA (W)	GIALLO/VERDE	VERDE
1		NERO O MARRONE	NERO O ROSSO
2		NERO O MARRONE	NERO O ROSSO

- Scollegare l'alimentazione di rete prima dell'intervento.
- Dopo l'installazione non si dovrà esercitare alcuna trazione sulle morsettiere.
- Collegare i fili di terra prima della fase e del neutro.

ESPAÑOL

CONEXIONES	ALIMENTACIÓN	MOTOR (EUR)	MOTOR (US)
L	FASE (L)		
N	NEUTRO (N)	AZUL	BLANCO
W	TIERRA (W)	AMARILLO/VERDE	VERDE
1		NEGRO O MARRÓN	NEGRO O ROJO
2		NEGRO O MARRÓN	NEGRO O ROJO

- Corte la alimentación de la RED antes de la intervención.
- Después de la instalación, no se debe efectuar ninguna tracción sobre los bornes de conexión.
- Conecte los cables de tierra antes de la fase y el neutro.

ENGLISH

TERMINALS	POWER SUPPLY	MOTOR (EUR)	MOTOR (US)
L	PHASE (L)		
N	NEUTRAL (N)	BLUE	WHITE
W	EARTH (W)	YELLOW/GREEN	GREEN
1		BLACK OR BROWN	BLACK OR RED
2		BLACK OR BROWN	BLACK OR RED

- Disconnect the main supply before carrying out any work.
- Ensure that no forces act on terminals after installation.
- Connect the earth wires before phase and neutral.

عربي

اتراف التلامس	التغذية الكهربائية	محرك (EUR)	محرك (US)
L	خط طور (L)		
N	خط بارد (N)	أزرق	أبيض
W	خط أرضي (W)	أصفر/أخضر	أخضر
1		أسود أو بني	أسود أو أحمر
2		أسود أو بني	أسود أو أحمر

- إفضل الكهرباء (خط طور) قبل التوصيل.
- عدم سحب الأسلاك (عند نقط التوصيل) بعد التوصيل.
- يجب توصيل الخط الأرضي قبل خط طور والبارد.

FRANCAIS

BORNES	ALIMENTATION	MOTEUR (EUR)	MOTEUR (US)
L	PHASE (L)		
N	NEUTRE (N)	BLEU	BLANC
W	TERRE (W)	JAUNE/VERT	VERT
1		NOIR OU MARRON	NOIR OU ROUGE
2		NOIR OU MARRON	NOIR OU ROUGE

- coupez l'alimentation secteur avant l'intervention.
- après l'installation, aucune traction ne doit s'exercer sur les borniers.
- branchez les fils de terre avant la phase et le neutre.

中文

接线端	电源	电机 (欧洲)	电机 (美国)
L	相线 (L)		
N	中线 (N)	蓝色	白色
W	地线 (W)	黄色/绿色	绿色
1		黑色或褐色	黑色或红色
2		黑色或褐色	黑色或红色

- 操作前，先切断该区域的电源。
- 安装后，不可再拉牵接线柱。
- 地线须在相线和中线之前插上。

DEUTSCH

KLEMMEN	NETZ	ANTRIEB (EUR)	ANTRIEB (US)
L	PHASE (L)		
N	NULLPUNKT (N)	BLAU	WEISS
W	ERDUNG (W)	GELB GRÜN	GRÜN
1		BRAUN O. SCHWARZ	ROTO. SCHWARZ
2		BRAUN O. SCHWARZ	ROTO. BRAUN

- Vor Durchführung der Arbeiten Netzanschluss freischalten, und gegen unbeabsichtigtes Einschalten sichern.
- Nach der Installation darf kein Zug auf die Klemmen entstehen.
- Zuerst Schutzleiter erst dann Phase und Mittelleiter anschließen.

РУССКИЙ

ЗАЖИМЫ	СЕТЬ	ПРИВОД (Европа)	ПРИВОД (США)
L	ФАЗА (L)		
N	НЕЙТРАЛЬ (N)	СИНИЙ	БЕЛЫЙ
W	ЗЕМЛЯ (W)	ЖЕЛТО-ЗЕЛЕНЫЙ	ЗЕЛЕНЫЙ
1		ЧЕРН. ИЛИ КОРИЧН.	ЧЕРН. ИЛИ КОРИЧН.
2		ЧЕРН. ИЛИ КОРИЧН.	ЧЕРН. ИЛИ КОРИЧН.

- Работы выполнять только при отключенной сети.
- После монтажа провода не должны действовать на зажимы внатяг.
- Вначале подсоединить провод заземления. Затем

UNITÀ DI PROGRAMMAZIONE DEL FINECORSO ELETTRONICO
LIMIT-SWITCH PROGRAMMING UNIT

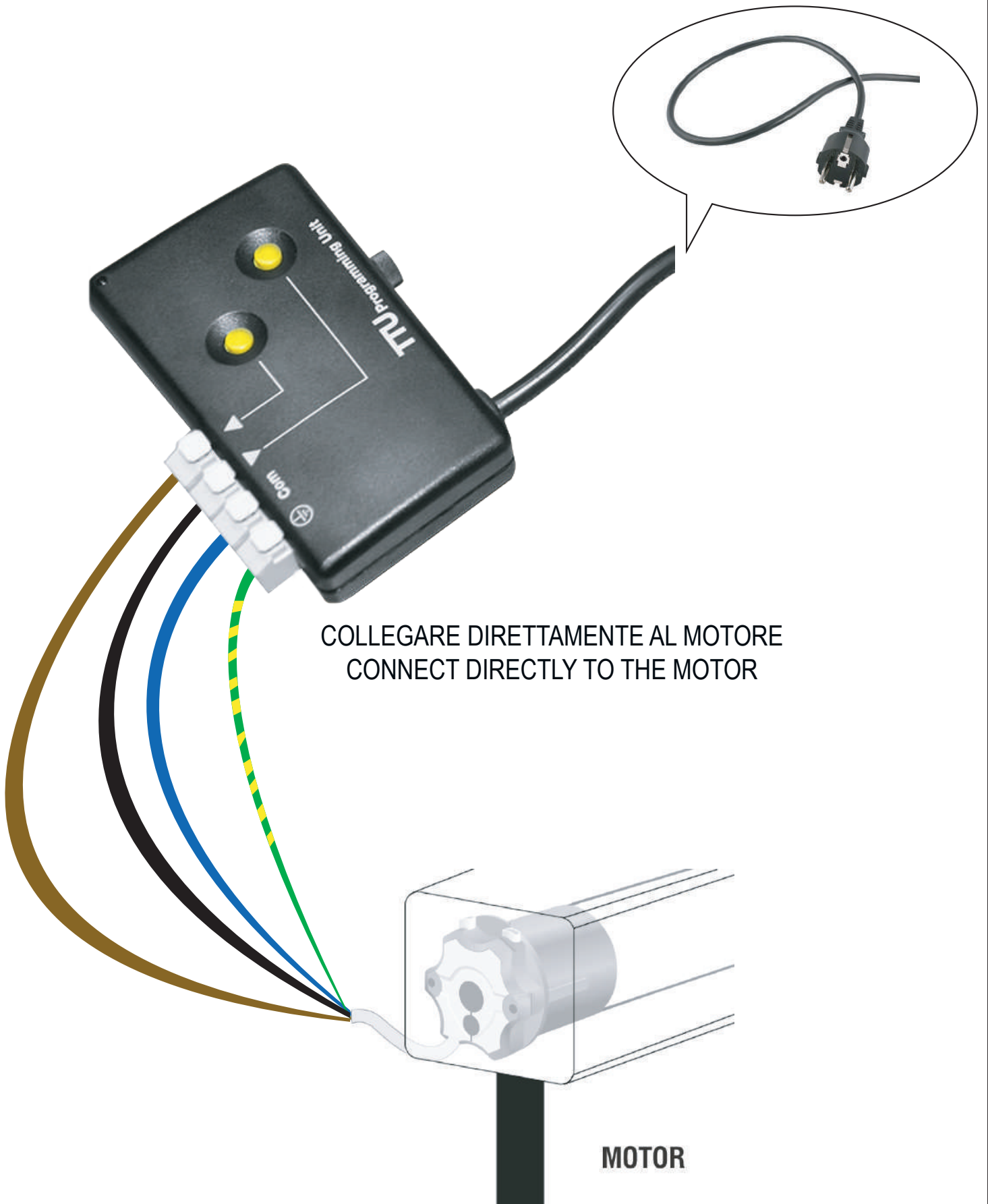

CANCELLAZIONE / MODIFICA DELLE POSIZIONI DI FINECORSA

AVVERTENZA: al momento della consegna, il motore è impostato sulla modalità di messa in esercizio. Per modificare i punti impostati è necessario, prima, procedere alla cancellazione dei punti preimpostati dalla fabbrica

QUANDO SI REIMPOSTA IL PUNTO DI FINE CORSA INFERIORE, È FONDAMENTALE, NON MODIFICARE OLTRE I 10CM IN PIÙ O IN MENO IL PUNTO GIÀ IMPOSTATO DI DEFAULT (ALTRIMENTI DECADE LA GARANZIA).

1. Dare tensione

2. Aprire lo schermo in posizione centrale.

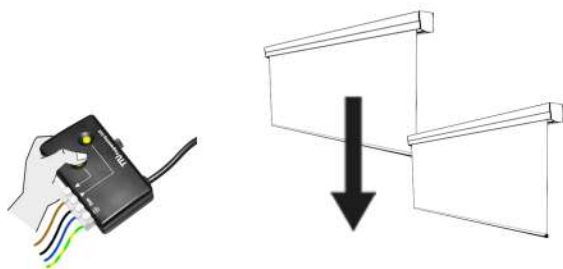

3. Premere contemporaneamente i due pulsanti sulla pulsantiera.
(Dopo circa 5 secondi il motore comanda un breve movimento di salita ed uno di discesa.
In questo modo la cancellazione delle posizioni di finecorsa è terminata.
A questo punto è possibile reimpostare le posizioni di finecorsa.)

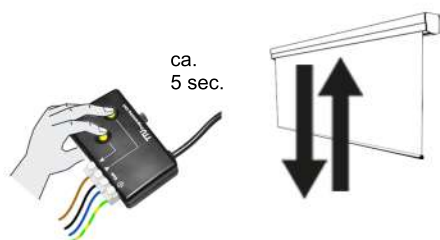

4. Sollevare la tela fino a circa 5 cm dalla battuta superiore premendo il pulsante salita.
(Quando si schiaccia il pulsante di salita, il motore parte lentamente, fa un breve STOP, per poi diventare più veloce.)



5. Premere di nuovo il pulsante di SALITA.
Sollevare la tela fino alla battuta superiore.
Una volta raggiunta la battuta non rilasciare il pulsante di salita.

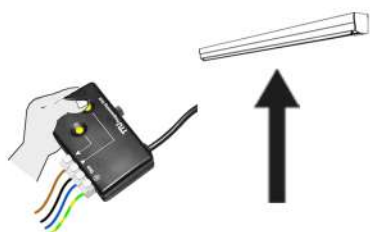

6. Senza rilasciare il pulsante SALITA premere il pulsante DISCESA fino a quando il motore non si arresta automaticamente a c.ca 30 cm dalla battuta.
(La posizione di finecorsa superiore è impostata)
Rilasciare entrambi i pulsanti.



7. Premere di nuovo il pulsante DISCESA.
Portare il telo VICINO alla posizione di finecorsa inferiore desiderata.
(Quando si schiaccia il pulsante di discesa, il motore parte lentamente, fa un breve STOP, per poi diventare più veloce.)

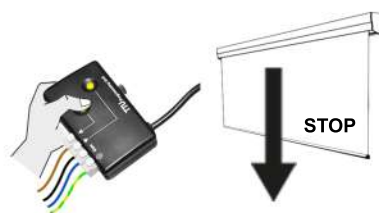

8. Abbassare la tela fino alla posizione di finecorsa inferiore desiderata.
(I pulsanti consentono di correggere la posizione della tela.)

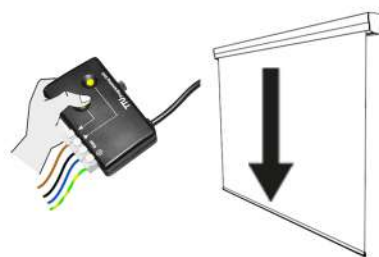

9. Premere il pulsante di SALITA, fino a quando il motore non si arresta automaticamente.
(La posizione di finecorsa inferiore è impostata.
L'impostazione delle posizioni di finecorsa è terminata.)

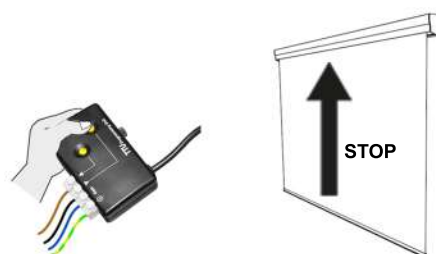

CANCELLATION / LIMIT POINTS' CHANGING

WARNING: when delivered, the motor is set on "working" mode. To change the set points, it is necessary, before, to proceed with the cancellation of the points set by the manufacturer.

IT IS ESSENTIAL NOT TO MODIFY THE DOWN LIMIT POINT SET BY MANUFACTURER OVER $\pm 10\text{CM}$

1. Connect the motor to the power supply;

2. Open the screen till the middle position;

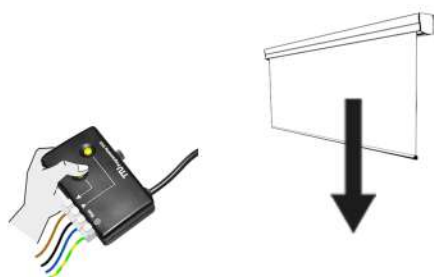

3. Push and hold both direction buttons at the same time until the motor briefly moves up and down. (In this way cancellation of the limit points has been done. It is possible to proceed with setting up of two new limit points)

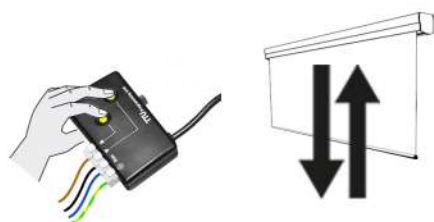

4. Make the screen go up till 5cm from the upper stop position by pushing the up button (when you push the up button, the motor starts working slowly, makes a short STOP and then becomes faster);



5. Push the up button again. Make the screen go up till the upper stop position. Once there, the motor will stop automatically; Do not leave the button, but keep the button pushed.

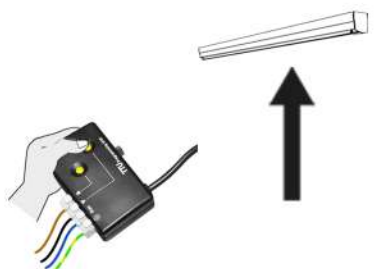

6. Keep the UP button apushed and push also a the same time the down button till the motor will not stop automatically about 30 cm. from the upper stop. (the upper limit point has been set);



7. Push the down button again. Make the screen go down till the approximate desired down limit position (when you push the down button, the motor starts slowly, makes a short STOP and then it becomes faster);

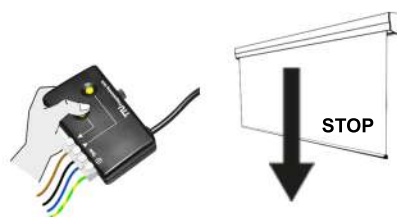

8. Make the screen go down till the desired position (the buttons allow to correct the screen's position);

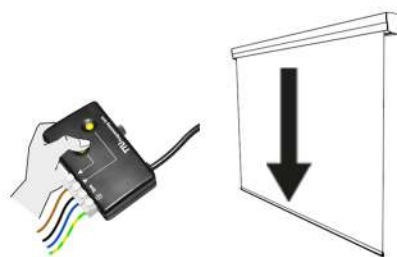

9. Push the up button till the motor will stop automatically (the down limit position has been set. Setting of the limit points has been done).

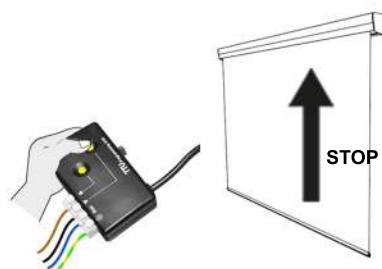

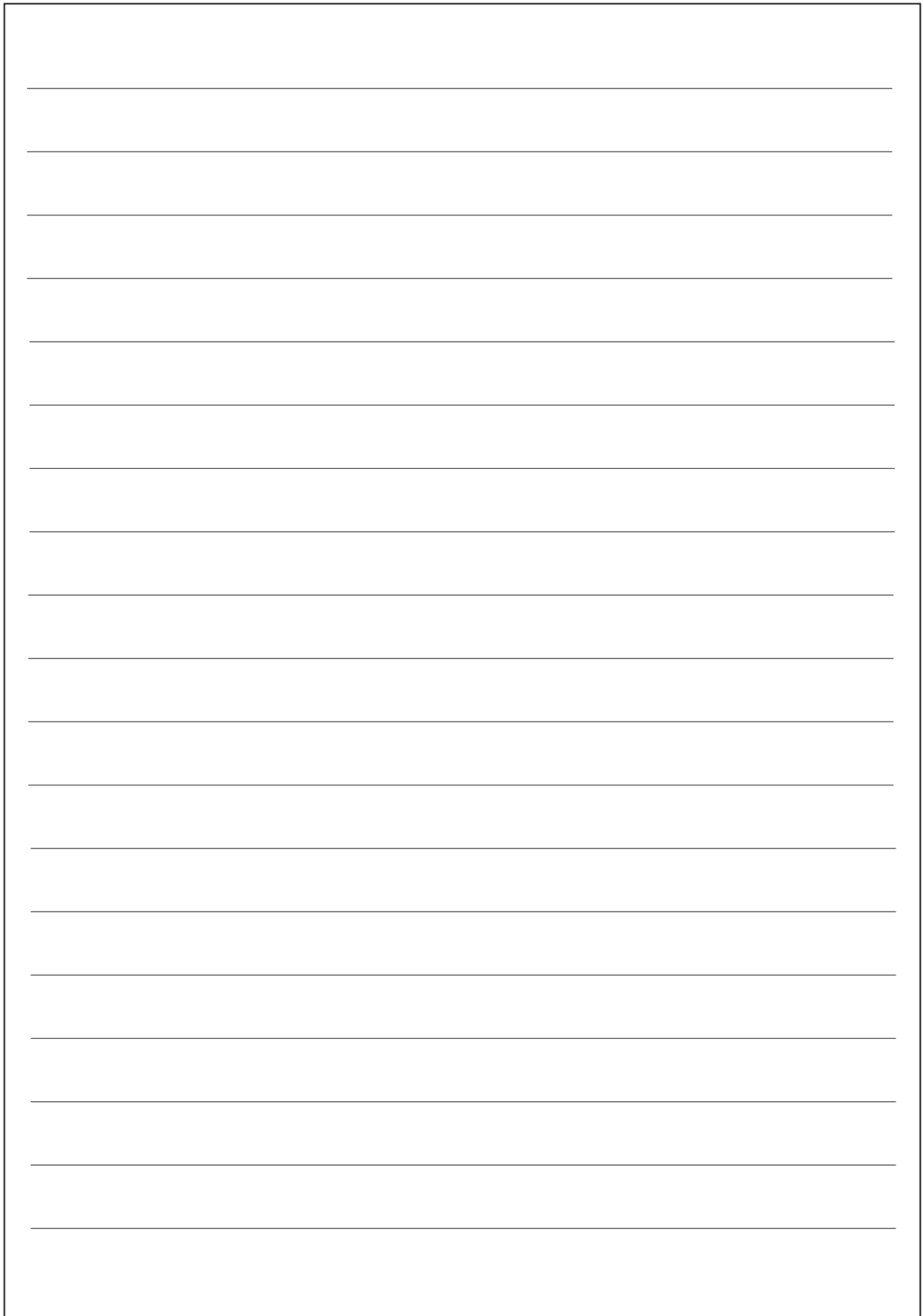

Screenline Srl - Via Nazionale 1/n IT38060 Besenello (TN) Italy
tel +39 0464 830003 - www.screenline.it - info@screenline.it

screenline.it