



MAXX-SERIES

DIGITAL POWER AMPLIFIERS

MA 16 / LP²

MA24/LP²

MA32/LP²

INDEX

1. SAFETY INSTRUCTIONS	1
1.1. GENERAL	1
1.2. INSTALLATION	3
1.3. VENTILATION AND COOLING	4
1.3.1. PASSIVE COOLING	4
1.3.2. ACTIVE COOLING	4
1.4. OPERATING CONDITIONS	6
2. TECHNICAL SPECIFICATION	7
2.1. OVERVIEW	7
2.1.1. MA32/LP ²	7
2.1.2. MA24/LP ²	8
2.1.3. MA16/LP ²	9
2.2. DIMENSIONS & WEIGHT	10
2.3. CONNECTIONS & CABLE	11
2.3.1. MAINS SUPPLY	11
AVAILABLE POWER CORDS	13
2.3.2. ETHERNET / DANTE	14
NETWORK MODI	14
DANTE IP SETTINGS	16
CONTROL IP SETTINGS	16
HOSTNAME	16
NETWORK SERVICES	16
2.3.3. MADI (AES10) / AES3	17
MADI Optical	17
MADI Coaxial / AES3	17
2.3.4. AMP OUTPUT	18
2.3.5. POWER DISTRIBUTION	19
3. SOFTWARE	20
3.1. IDFM (FIRMWARE UPDATE AND IP CONTROL)	20
3.1.1. DISCOVERY	21
3.1.2. IP SETTINGS	22
3.1.3. FIRMWARE STORAGE	23
3.1.4. FIRMWARE UPDATE	24
3.2. DSP (internal)	25
3.3. USER INTERFACES	26
3.3.1. DISPLAY / BUTTONS	26
DISPLAY MENU	26
OVERVIEW	27
DISPLAY DEVICE LOCK	27

3.3.2. POWER LED	28
3.3.3. WEBSITE	29
HEADER	29
PAGES	30
SAVE INTERNAL STORAGE	30
PSU LIMIT	30
AMP STATUS	31
FOOTER	32
OVERVIEW	33
INTERFACES	53
DEVICE	55
MUTEGROUPS	57
PRESETS	58
LOGGING	59
METERING	60
3.3.4. ERROR CODES	61
3.3.5. RESTful API	63
GET DEVICE INFOMRATIONS	64
SET CHANNEL MUTE	64
GET CHANNEL VOLUME OPTIONS	65
REMOVE PRESET WITH NAME TEST	65
4. PACKAGING	66
5. DISPOSING	67
6. SERVICE	68
6.1. FUSES	68
6.2. FIRMWARE UPDATE	68
6.3. FILTER CLEANING	68
6.4. SPARE PARTS	69
7. EU Declaration of Conformity	71
7.1. EN 55032:2012	71
7.2. EN 55103-2	71
7.3. EN 62368-1:2014/AC:2015	72
7.4. MANUFACTURER	72
8. FCC Declaration of Conformity	73

Chapter 1. SAFETY INSTRUCTIONS

1.1. GENERAL

Before using the product, please read this manual and follow all Safety Instructions. They are used to protect you, help to avoid equipment defects and damages resulting from improper use. Keep this manual in a safe place.



CAUTION: THE POWER SUPPLY CORD IS USED AS THE MAIN DISCONNECT DEVICE, ENSURE THAT THE SOCKET-OUTLET IS LOCATED/INSTALLED NEAR THE EQUIPMENT AND IS EASILY ACCESSIBLE

ATTENTION: LE CORDON D'ALIMENTATION EST UTILISÉ COMME INTERRUPTEUR PRINCIPAL. LA PRISE DE COURANT DOIT ÊTRE SITUÉE OU INSTALLÉE À PROXIMITÉ DE L'ÉQUIPEMENT ET ÊTRE FACILE D'ACCÈS



CAUTION - DANGER OF EXPLOSION IF BATTERY IS INCORRECTLY REPLACED. REPLACE ONLY WITH THE SAME OR EQUIVALENT TYPE.

ATTENTION - DANGER D'EXPLOSION LORSQUE LA BATTERIE N'EST PAS REMPLACÉE CORRECTEMENT. REMPLACER UNIQUEMENT AVEC DES BATTERIES IDENTIQUES OU D'UN TYPE ÉQUIVALENT



CAUTION - THESE SERVICING INSTRUCTIONS ARE FOR USE BY QUALIFIED SERVICE PERSONNEL ONLY. TO REDUCE THE RISK OF ELECTRIC SHOCK DO NOT PERFORM ANY SERVICING OTHER THAN THAT CONTAINED IN THE OPERATING INSTRUCTIONS UNLESS YOU ARE QUALIFIED TO DO SO.

ATTENTION - CES CONSIGNES D'ENTRETIEN DOIVENT ÊTRE UNIQUEMENT EMPLOYÉES PAR LE PERSONNEL DE SERVICE QUALIFIÉ. POUR RÉDUIRE LE RISQUE DE CHOC ÉLECTRIQUE NE PAS EFFECTUER DES RÉPARATIONS AUTRES QUE CEUX CONTENUS DANS LES INSTRUCTIONS D'UTILISATION À MOINS QUE VOUS SOYEZ QUALIFIÉ POUR LE FAIRE



The amplifier is a device of protection class 1. Make sure that the protective conductor (earth) is connected properly. A missing earth can lead to dangerous voltages at the enclosure!



Keep the device away from dust, moisture, water and other liquids! In such case, the further usage is prohibited!



The amplifier has a relatively high output power and possibly can be a hazard for people and speakers. Pay particular attention to any defective set volume.



Do not touch the housing of the device, during operation. The surfaces can be hot. After switching off the device, wait 30 minutes till touching the device.



In the following cases it is necessary to return the amplifier for examination to the manufacturer. Contact details can be found on our website: www.innosonix.de

- The unit has been dropped, mechanically damaged or treated improperly.
- The power cord or plug has been damaged.
- Objects have fallen into the unit.
- Liquid has been spilled into the unit.
- The unit is not operating normally.
- The device displays errors.

1.2. INSTALLATION

All devices can be installed in a 19-inch rack. Screw the devices at each of the two Mounting holes of the mounting bracket on the front. Use Screws with a sufficiently large head diameter and lock washers.

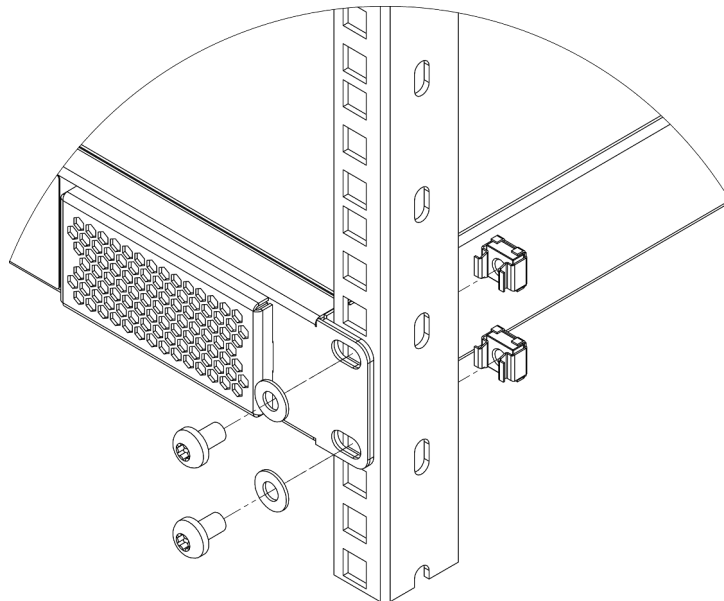

Figure 1. MAXX/LP² installation

We recommend mounting the unit cantilevered. The use of guide rails and bearing surfaces can affect the convection. Make sure there is at least **1 RU** between devices when **FAN MODE** is set to **PASSIVE**. (See. [VENTILATION AND COOLING](#))

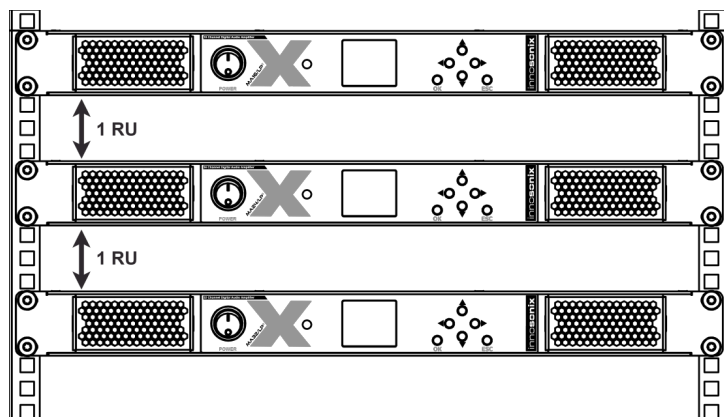

Figure 2. MAXX/LP² rack mounting

1.3. VENTILATION AND COOLING



Built-in and 19-inch racks must be ventilated adequately.

1.3.1. PASSIVE COOLING

Passive Cooling is activated by setting the **FAN MODE** to **PASSIVE**. This Mode is recommended if the amplifier is installed directly in an audience space or similar where no FAN noises are acceptable. In all other situations, **ACTIVE COOLING** should be the preferred mode.

When a critical temperature is reached, all channels are shut down until a temperature sinks, and it's safe to power on the channels again.



The devices must not be placed directly over each other since the housing is cooled by convection. (see. [RACK MOUNTING](#))

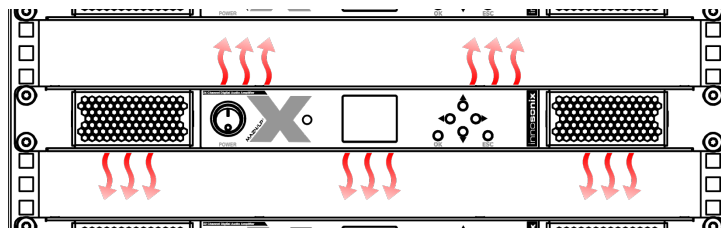

Figure 3. MAXX/LP² Convection

1.3.2. ACTIVE COOLING

The active cooling system inside the device creates front to back ventilation.

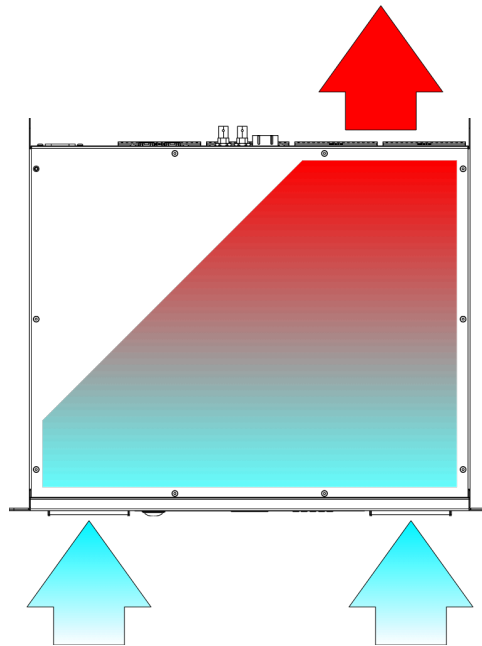

Figure 4. MAXX/LP² Ventilation

Table 1. Active Fan Modes

SILENT	Fans become active when internal temperature reach ~50°C, otherwise fans are off.
NORMAL	Fans are always active

1.4. OPERATING CONDITIONS

Enviromental operating temperature	0 - 40°C			
Thermal dissipation	Fan, variable speed, temperature controlled front to rear airflow / passiv cooled			
	32 CH			
	@230V		@110V	
amps power off	24 kcal/h	95 BTU/h	24 kcal/h	95 BTU/h
idle	49 kcal/h	194 BTU/h	50 kcal/h	198 BTU/h
1/8 power @ 4 Ohm	104 kcal/h	412 BTU/h	105 kcal/h	416 BTU/h
	24 CH			
	@230V		@110V	
amps power off	22 kcal/h	87 BTU/h	22 kcal/h	87 BTU/h
idle	40 kcal/h	159 BTU/h	40 kcal/h	159 BTU/h
1/8 power @ 4 Ohm	78 kcal/h	309 BTU/h	79 kcal/h	313 BTU/h
	16 CH			
	@230V		@110V	
amps power off	19 kcal/h	75 BTU/h	19 kcal/h	75 BTU/h
idle	30 kcal/h	119 BTU/h	32 kcal/h	127 BTU/h
1/8 power @ 4 Ohm	43 kcal/h	171 BTU/h	44 kcal/h	174 BTU/h

Chapter 2. TECHNICAL SPECIFICATION

2.1. OVERVIEW

2.1.1. MA32/LP²

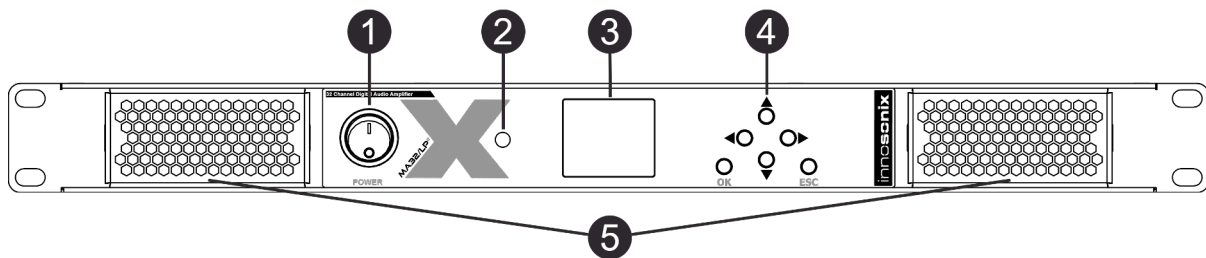

Figure 5. MA32/LP² front view

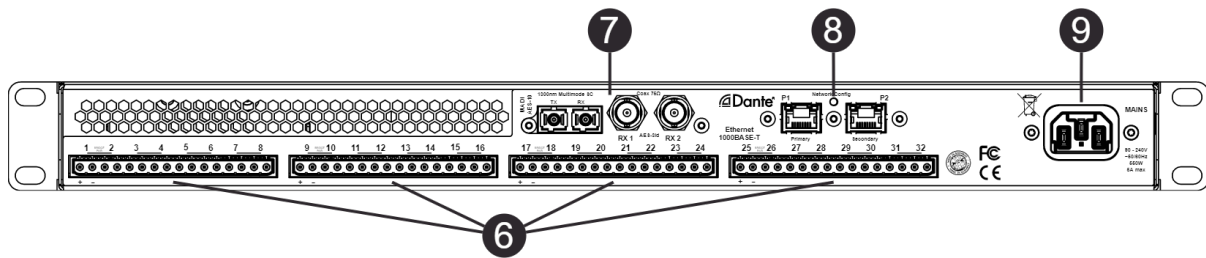

Figure 6. MA32/LP² back view

Table 2. DEVICE ELEMENTS

NR	DESCRIPTION	REFERENCE
1	POWER SWITCH	MAINS SUPPLY
2	POWER LED	POWER LED
3	DISPLAY	DISPLAY / BUTTONS
4	BUTTONS	DISPLAY / BUTTONS
5	VENTILATION GRILLS	SERVICE
6	AMP OUTPUTS	AMP OUTPUT
7	MADI	MADI (AES10) / AES3
8	ETHERNET/DANTE	ETHERNET / DANTE
9	MAINS SUPPLY	MAINS SUPPLY

2.1.2. MA24/LP²

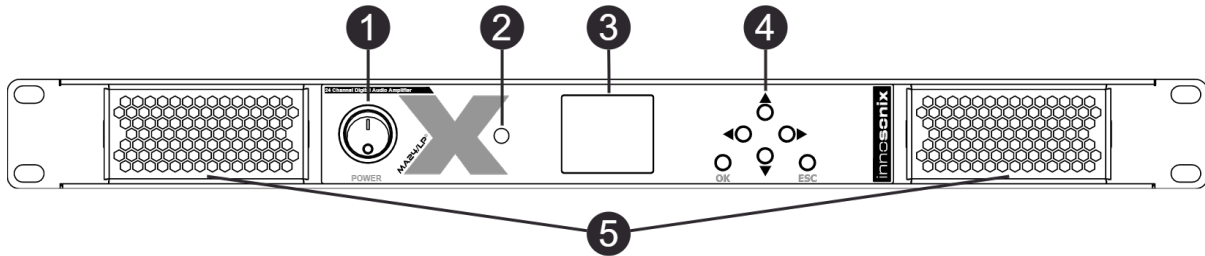

Figure 7. MA24/LP² front view

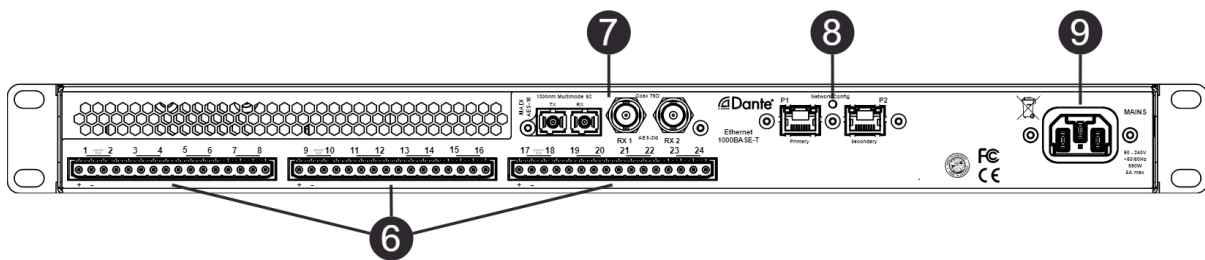

Figure 8. MA24/LP² back view

Table 3. DEVICE ELEMENTS

NR	DESCRIPTION	REFERENCE
1	POWER SWITCH	MAINS SUPPLY
2	POWER LED	POWER LED
3	DISPLAY	DISPLAY / BUTTONS
4	BUTTONS	DISPLAY / BUTTONS
5	VENTILATION GRILLS	SERVICE
6	AMP OUTPUTS	AMP OUTPUT
7	MADI	MADI (AES10) / AES3
8	ETHERNET/DANTE	ETHERNET / DANTE
9	MAINS SUPPLY	MAINS SUPPLY

2.1.3. MA16/LP²

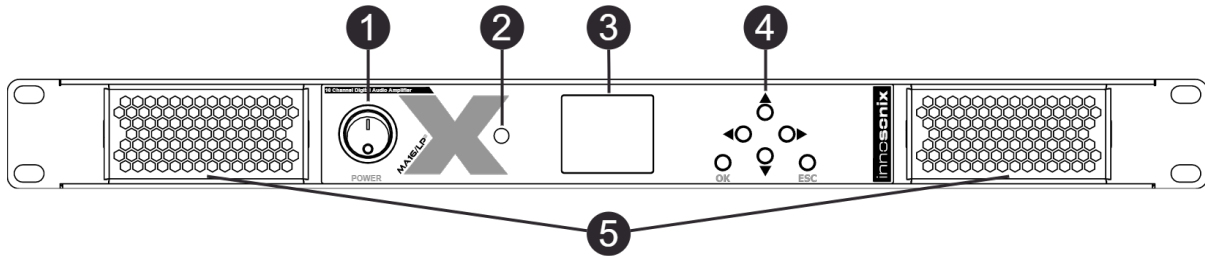

Figure 9. MA16/LP² front view

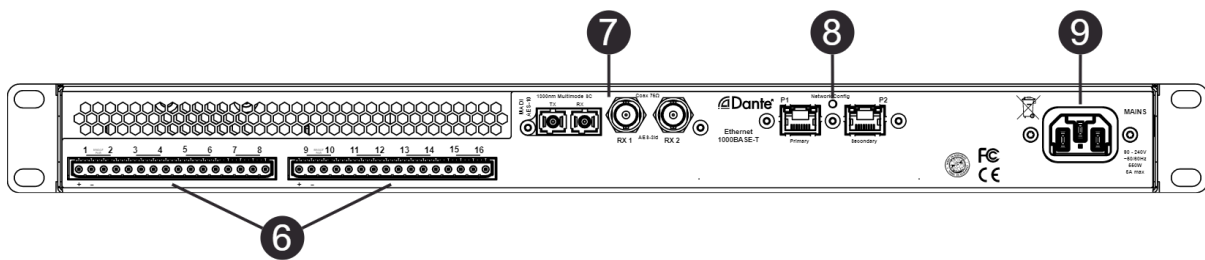

Figure 10. MA16/LP² back view

Table 4. DEVICE ELEMENTS

NR	DESCRIPTION	REFERENCE
1	POWER SWITCH	MAINS SUPPLY
2	POWER LED	POWER LED
3	DISPLAY	DISPLAY / BUTTONS
4	BUTTONS	DISPLAY / BUTTONS
5	VENTILATION GRILLS	SERVICE
6	AMP OUTPUTS	AMP OUTPUT
7	MADI	MADI (AES10) / AES3
8	ETHERNET/DANTE	ETHERNET / DANTE
9	MAINS SUPPLY	MAINS SUPPLY

2.2. DIMENSIONS & WEIGHT

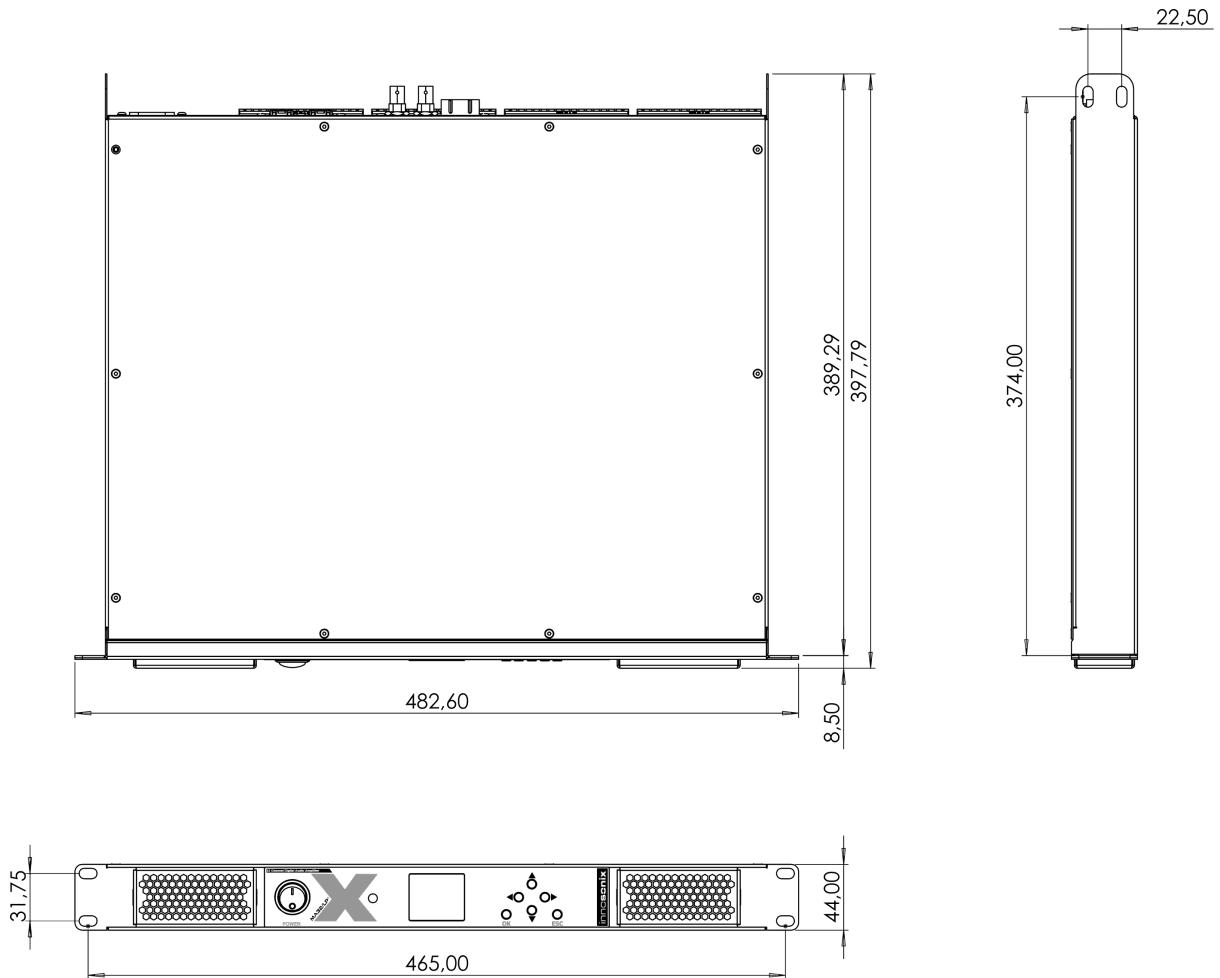

Figure 11. MAXX/LP² dimensions

Dimensions	W 482.60mm (19") H 44.00mm (1 RU), D 389.29mm		
	32CH	24CH	16CH
Weight	6.0 kg	5.7 kg	5.4 kg

2.3. CONNECTIONS & CABLE

Control input connectors	RJ45 (100Mbit/s Ethernet)
Audio signal input connectors	RJ45 (DANTE), BNC 75R (MADI Coax, AES3id), SC Optic (MADI Fibre)
Speaker connector	Wuerth Elektronik 691352710002
	Phoenix Contact MSTB 2,5/ 2-ST - 1754449
	Phoenix Contact MSTB 2.5/16-ST-5,08 - 1757158
AC mains	C13

A chapter that describes available hardware interconnections with recommendations to cable and settings.

2.3.1. MAINS SUPPLY

See ❶ and ❸ [MA32LP2 BACK VIEW](#)

Power supply	Universal, regulated switch mode with PFC (Power Factor Correction)	
Operating Voltage	90 - 264VAC 50/60Hz	
AC Current typ.	4.85A	
Inrush Current	60A max.	
Suggested circuit breaker	B16	
Earth Leakage Current	<0.75mA / 240V	

32 CH Version		
Power Factor	@230V	@110V
amps power off	0.46	0.85
idle	0.64	0.95
1/8 power @ 4 Ohm	0.96	0.98
Consumption / current draw	@230V	@110V
amps power off	29W, 0.13A	29W, 0.26A
idle	56W, 0.24A	57W, 0.54A
1/8 power @ 4 Ohm	322W, 1.4A	332W, 3.0A

24 CH Version		
---------------	--	--

Power Factor	@230V	@110V
amps power off	0.44	0.83
idle	0.58	0.93
1/8 power @ 4 Ohm	0.94	0.99
Consumption / current draw	@230V	@110V
amps power off	26W, 0.11A	26W, 0.24A
idle	46W, 0.20A	38W, 0.35A
1/8 power @ 4 Ohm	241W, 1.05A	247W, 2.25A

16 CH Version		
Power Factor	@230V	@110V
amps power off	0.41	0.81
idle	0.52	0.90
1/8 power @ 4 Ohm	0.89	0.99
Consumption / current draw	@230V	@110V
amps power off	23W, 0.10A	24W, 0.22A
idle	36W, 0.16A	38W, 0.35A
1/8 power @ 4 Ohm	152W, 0.66A	164W, 1.49A



The device contains an internal fuse see: [FUSES](#)

The Amplifier comes with a power cord according to the planned place of use. See [SERVICE](#) to order a new or different power cord.

AVAILABLE POWER CORDS

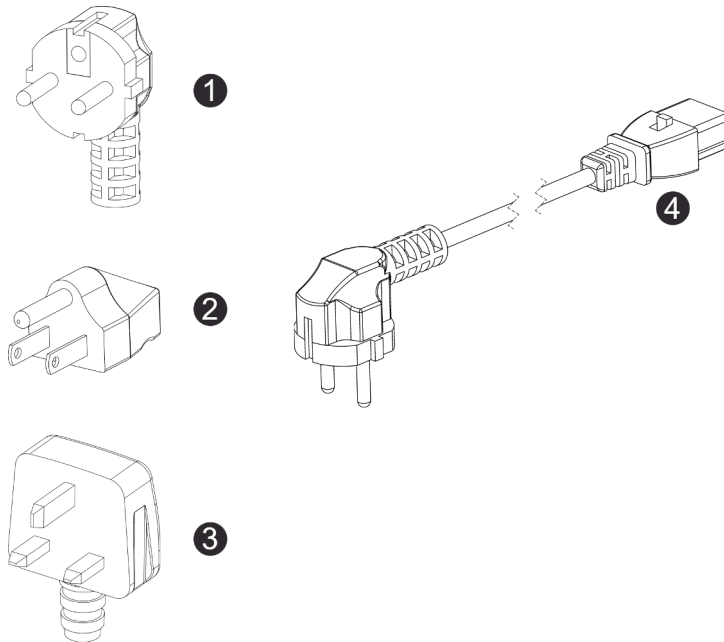

NR	DESCRIPTION
1	3-pin Schuko CEE 7/7
2	3-pin USA NEMA5-15
3	3-pin GB BS 1363A
4	IEC-LOCK C13

To release the cable from the amplifier, the red Button has to be pushed to the back.

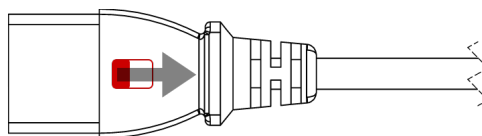

2.3.2. ETHERNET / DANTE

See 7 MA32LP2 BACK VIEW

There are two different network devices inside the amplifier, the Control Module and the Dante® Module. There are three different network modes that determine which device can be reached at which network port.



Do not connect both Port to the same Switch if no different VLANs are configured.

NETWORK MODI

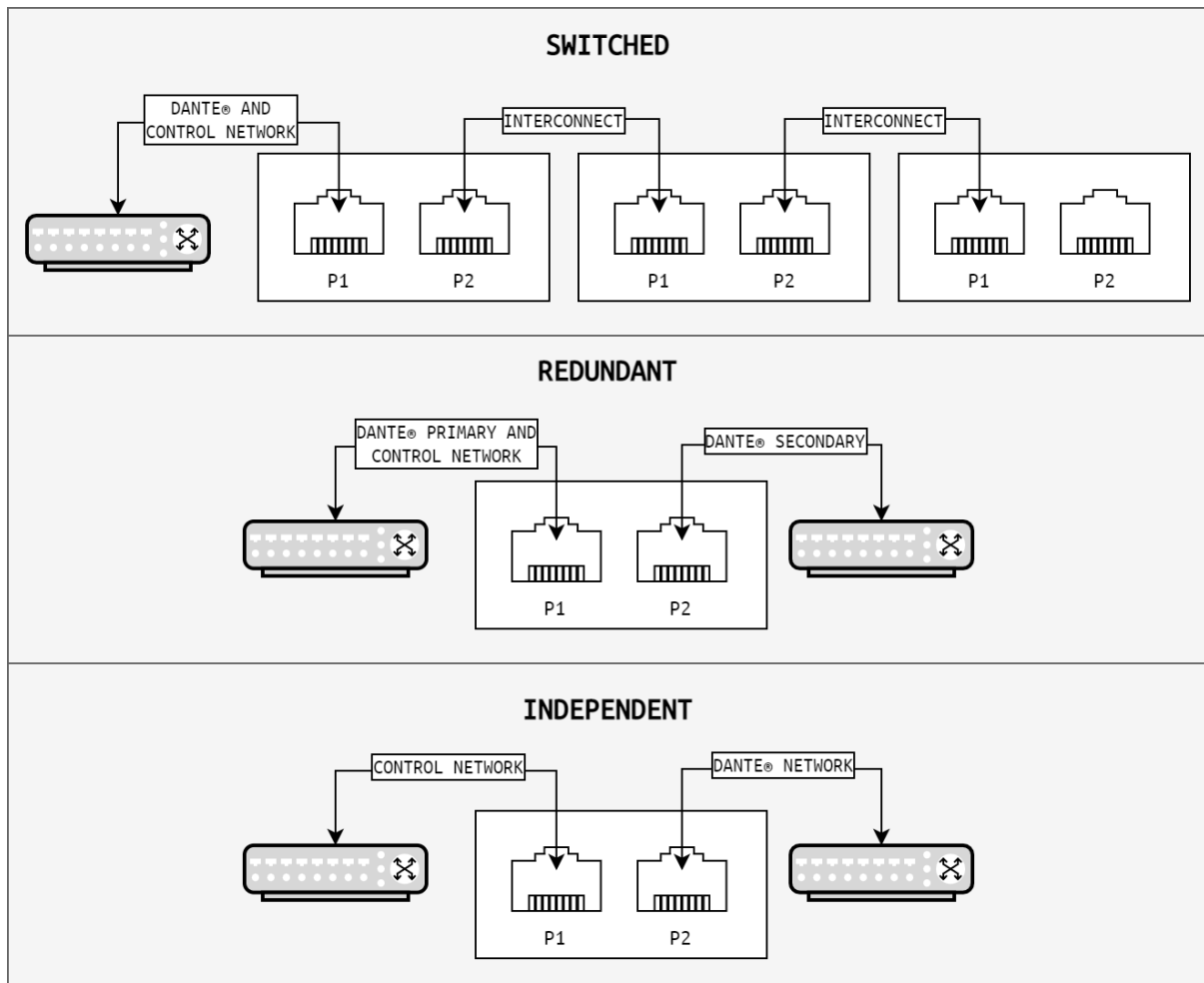

Figure 12. NETWORK MODI

To **change** the network modes, the **Dante Controller** Software is required. ([DOWNLOAD HERE](#))

Open the **Dante Controller** and go to Device View:

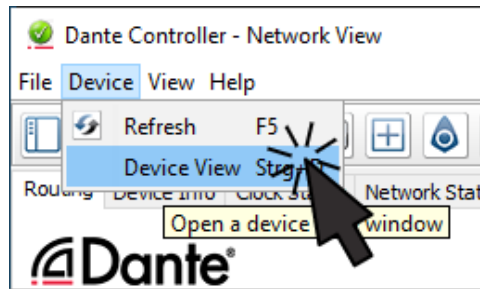

Figure 13. Dante Controller

The Device View Popup appears:

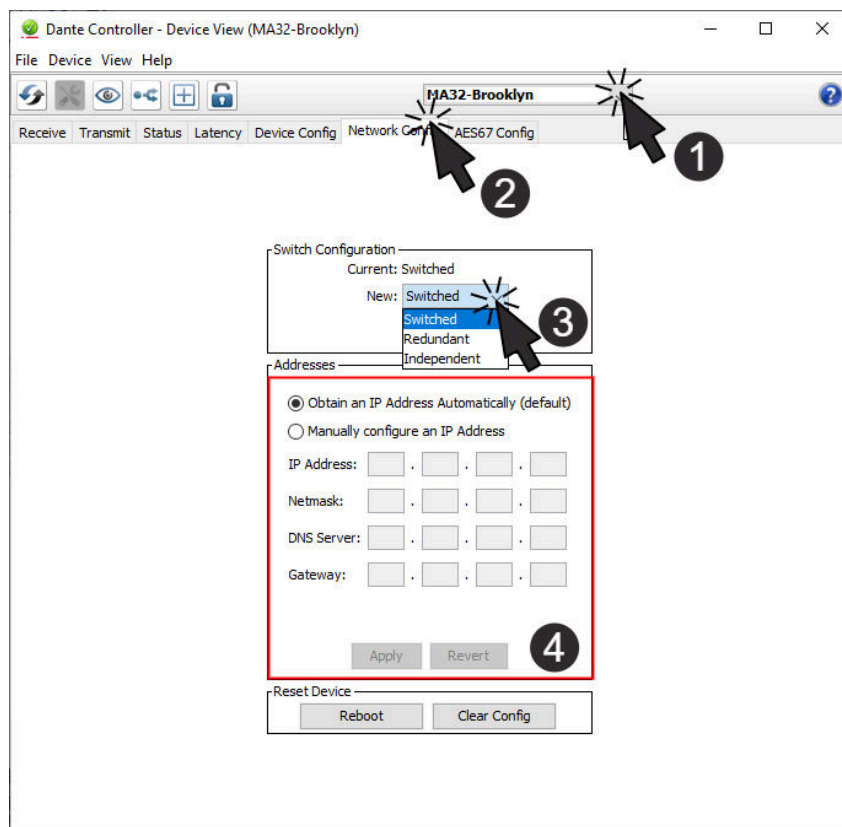

Figure 14. Dante Device View

Select the device in the Dropdown **1** and change to tab **Network Config 2**. The currently selected network mode appears in the **Switch Configuration** box. By selecting the new Mode **3**, a Popup opens that asked, whether you're really sure to do that. After clicking **YES**, the Brooklyn Module inside the Amplifier restart, so it can take a few seconds till the Dante Device is back online.

DANTE IP SETTINGS

To control and change IP Settings of DANTE, please use ④ in [Dante Device View](#).

CONTROL IP SETTINGS

There are several ways to change the **IP** of an Amplifier. See [DISPLAY MENU](#) to change on Display Menu, [DEVICE](#) to change on Website or use the external software **IDFM** (see [IP SETTINGS](#)).

There are three different IP Types available:

Table 5. IP TYPES

TYPE	DESCRIPTION
static	set IP, SUBNET and GATEWAY manually
dhcp	system tries to get a DHCP release, there is also an auto ip fallback, if no lease available
auto-ip	force zeroconf IP, device will get an address with a 169.254/16 prefix (that is, 169.254.xxx.xxx)

HOSTNAME

With mDNS the device is also available with its hostname. With hostname **AMP1** the local name is **AMP1.local**. The Name can be used to call every network service.

There are several ways to change the **Hostname** of an Amplifier. See [DEVICE](#) to change on Website or use the external software **IDFM**.

NETWORK SERVICES

- Full remote control via the website hosted on the device (see [WEBSITE](#))
- REST-API, JSON based web service for integration in media control systems (see [RESTful API](#))
- mDNS name resolution and servicediscovery ([INFO HERE](#))
- syslog integration to send notifications to external syslog server ([INFO HERE](#))

2.3.3. MADI (AES10) / AES3

See [8 MA32LP2 BACK VIEW](#)

MADI (**M**ultichannel **A**udio **D**igital **I**nterface) or **AES10** is a standard that defines electrical characteristics and the data format of an interface that carries multiple channels of digital audio. There are two Coaxial Inputs available, which also can be used as AES3 Inputs, one optical input and an optical output. On every Input the device supports **44.1kHz / 48kHz** with **56 / 64** channels and **88.2 kHz / 96kHz** with **28 / 32** channels.

MADI Optical

To use the Optical MADI interface, a **1300nm multimode** cable with **SC** connectors is required.

MADI Coaxial / AES3

The two BNC (75 Ohm) jacks are multifunctional inputs and can be used as AES10 MADI or AES3 interface.

To use the BNC input for AES3, a 110 to 75 Ohm impedance transformer like [\(NADITBNC-F\)](#) or [\(NADITBNC-FX\)](#) is required.

Every AES3 input has an asynchronous samplerate converter enabled which can handle samplerates from 32kHz - 192kHz.

2.3.4. AMP OUTPUT

See ⑥ [MA32LP2 BACK VIEW](#) To connect speakers, use 2-Pol Terminal Blocks [SERVICE](#).

Output Power (EIAJ Test Standard 1kHz 1% THD)	4Ω	8Ω	8Ω Bridge-Mode
	50W	30W	100W
Max output Voltage	24 V _{peak}		
Max output Current	10 A _{peak}		
DC Offset	<25mV		
Frequency response	10Hz-20kHz / 4-8Ω: +0.0 -1.5dB		
S/N typ	108dBA		
Analog Gain	Software Adjustable, 0dBFS on any Input Interface ⇒ 20V _p - 60V _p (default: 32V _p)		
THD+N @ 4Ω	1W	10W	
	< 0.05%	< 0.1%	
SMPTE IMD	< 0.1%		
CCIF IMD	< 0.1%		
Output impedance	typ 60 mΩ		
Crosstalk	channel enabled		channel disabled
	typ < 70dB	typ 90dB (distant channels)	typ < 120dB
Latency @48kHz	1.1ms		
Protection	Overtemperature, DC and Overcurrent		

2.3.5. POWER DISTRIBUTION



- The power supply can deliver 500W continuous power. To ensure a stable operation in overload situations, the MAXX/LP² involves an overall power limiter. With an attack time of 100ms and a release of 3s the limiter softly reduces the gain of all channels simultaneously not to exceed the maximum available power. At 110V lines, a derating of 20% must be considered.
- The pulse power of 32 * 35W is buffered through capacitors and is certainly available as a short burst only.
- An amplifier efficiency of 85% can be expected.
- All amplifiers are sourced by one powersupply.
- Assuming an evenly distribution of load between all channels, the MAXX/LP² is able to give 14W continuous sine power per channel. At 110V line it is after all 12W.

Chapter 3. SOFTWARE

3.1. IDFM (FIRMWARE UPDATE AND IP CONTROL)

The IDFM (Innosonix **D**iscovery and **F**irmware **M**anager) is available for Windows 10, MAC OSX and Linux. Have a look at our [Download Area](#)

It is designed to discover MAXX Devices across subnets and across network modes (See [ETHERNET / DANTE](#)). It also handles Firmware updates of MAXX Devices.

3.1.1. DISCOVERY

The Discovery process starts after opening the IDFM Tool. All available Devices will appear in the list view.



Be sure the firewall allows TCP and UDP connections.

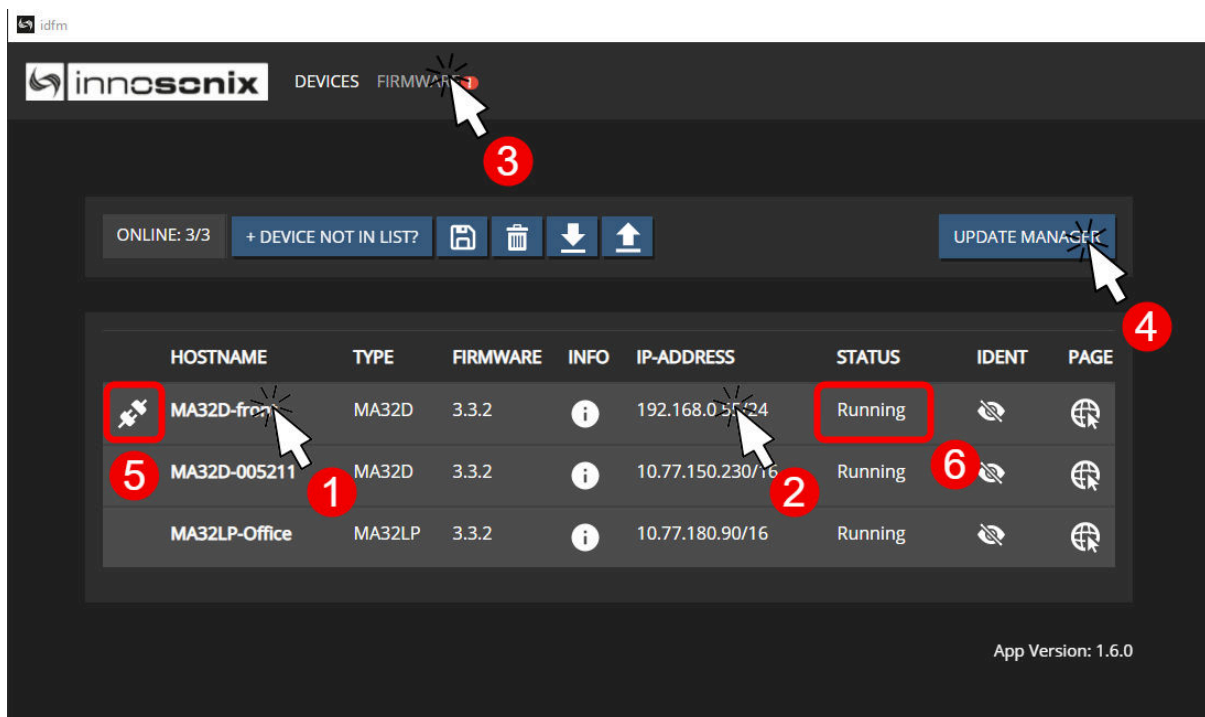

Figure 15. IDFM Discovery

NR	DESCRIPTION	REFERENCE
1	Change Hostname	
2	Change IP Settings	IP SETTINGS
3	Download / Import Firmware Files	see FIRMWARE
4	Update Devices	UPDATE
5	Device not in same Subnet ⇒ cannot be updated	
6	Actual Device Status (Update Status)	

3.1.2. IP SETTINGS

After clicking on the IP Address in [IDFM Discovery](#) view, following popup appears to change IP Settings.

IP Settings are described here [Control IP](#)

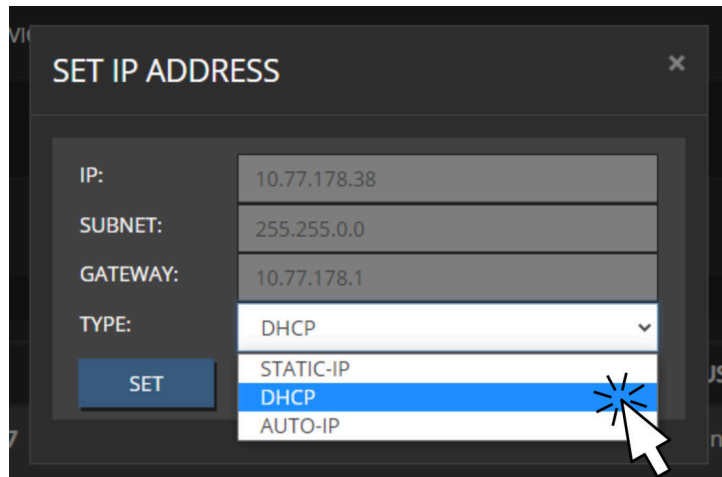

Figure 16. IDFM IP Settings

3.1.3. FIRMWARE STORAGE

To update the firmware of a MAXX Device, the correct Firmware must be available in the firmware storage.

If there is no Internet connection available, the newest firmware cannot be loaded from our server **2**. With **1** a firmware image files can be uploaded manually.

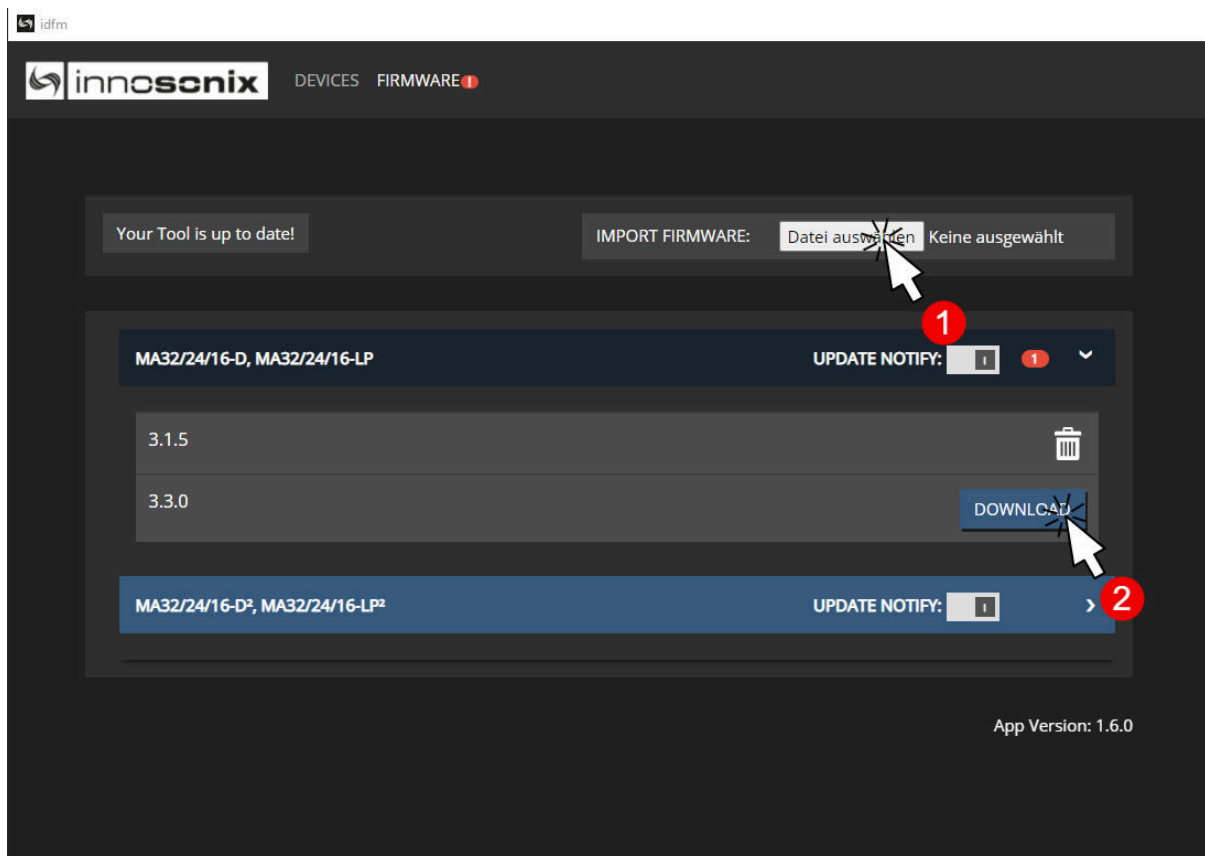

Figure 17. IDFM Firmware storage

3.1.4. FIRMWARE UPDATE

After loading a correct firmware file to the [FIRMWARE STORAGE](#), the firmware can be selected in the firmware update popup. If no Firmware is selected, the device will be ignored. After confirming the update, the update status can be seen at [6](#) on [IDFM Discovery](#).



After firmware Update completed, the Device restarts automatically.

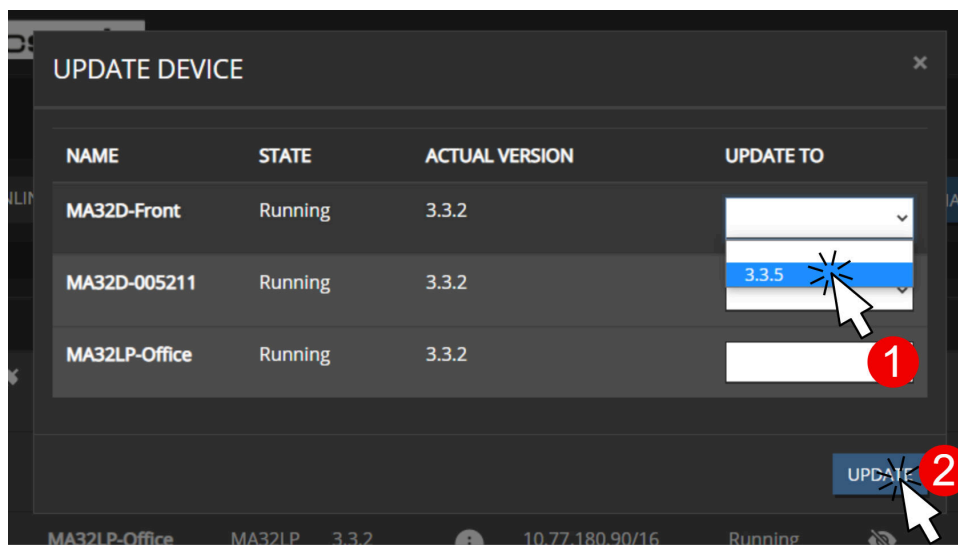

Figure 18. IDFM Firmware update

3.2. DSP (internal)

A DSP is a digital signal processing chain inside the FPGA that calculates the volume control, filtering and limiting parameters on the selected Input Source. There are as many DSP channels as amplifier outputs on the MAXX device. DSPs are "hardwired" to the corresponding amplifier, e.g. DSP channel 1 supplies an amplifier that is wired to CH1 Jack on the rear panel.

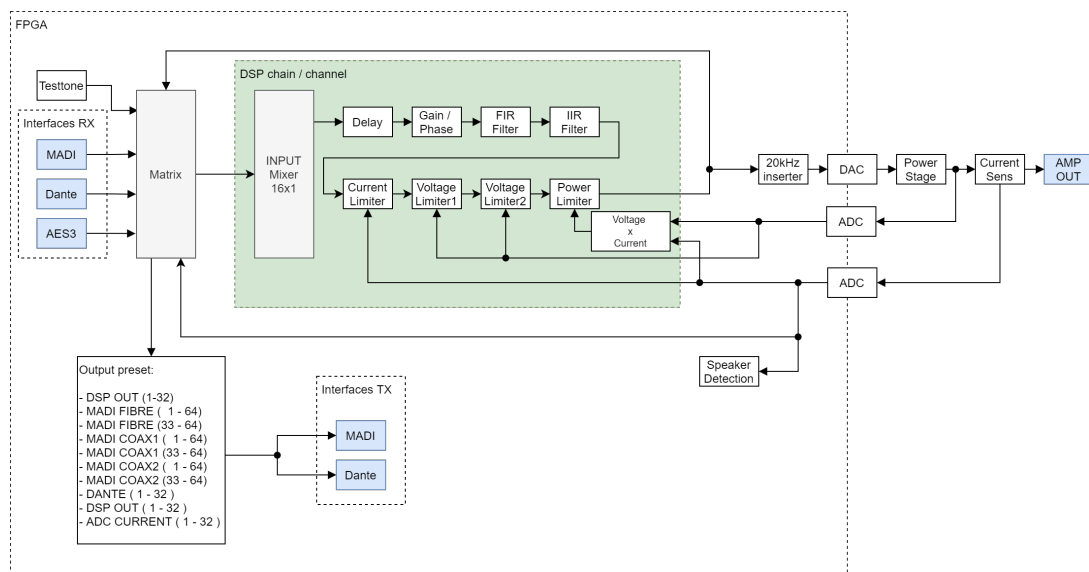

Figure 19. DSP Block Image

DSP Features

Architecture	FPGA based 32-bit fixed point
Inputs	16 x input matrix
	sine, white- pink- brown-noise
	Mute, Volume, Phase
Filter per channel	32 x EQ / Highpass / Lowpass
Filter types	bell, notch, highshelf, lowshelf
High- Lowpass types	6 - 48dB/Oct, Bessel, Butterworth, Linkwitz/Riley, Variable Q
FIR Filter	2048 Tabs, ASCII file import
Delay	48000 Samples / 330m / 1000ms per channel
CurrentLimiter	Threshold [Ap]
VoltageLimiter	2 x Threshold [Vp], Attack, Release
Powerlimiter	Threshold [W], Attack, Release
Speakerdetection	20kHz Pilot Tone generating with Volume, Threshold, Debounce

3.3. USER INTERFACES

3.3.1. DISPLAY / BUTTONS

See ③ and ④ on [FRONT VIEW](#)

DISPLAY MENU



Figure 20. MENU STRUCTURE

Table 6. MENU PAGES

NR	DESCRIPTION
①	Overview Page with Hostname, IP and Channel Status (see. OVERVIEW)
②	Status Page with Temperatures and PSU Load and Fan Speeds
③	Info Page with Model, Serial, Software Version and Software Options
④	Network Settings Page to change IP type and address

OVERVIEW

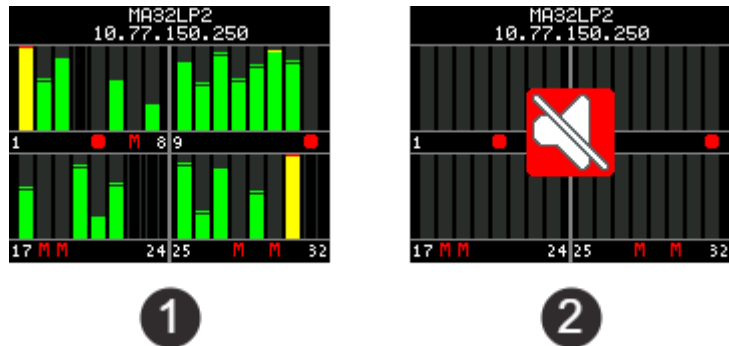

Figure 21. OVERVIEW EXAMPLES

The Overview Page appears at startup, and after a 30 seconds timeout, if another page is selected and no user input occurs. Every channel has its own Levelmeter from **-60dBFS** to **0dBFS** with **PEAK** as a bar and **HOLD** as a horizontal line. The Overview ① shows **CHANNEL MUTE** State (CH 7, 18, 19, 18, 30), if the amplifier channel is **disabled** (CH 4, 23, 24, 32) or the amp channel has an **error** (CH 5, 16).

If **Master Mute** is enabled, the crossed out loudspeaker appears ②.

DISPLAY DEVICE LOCK

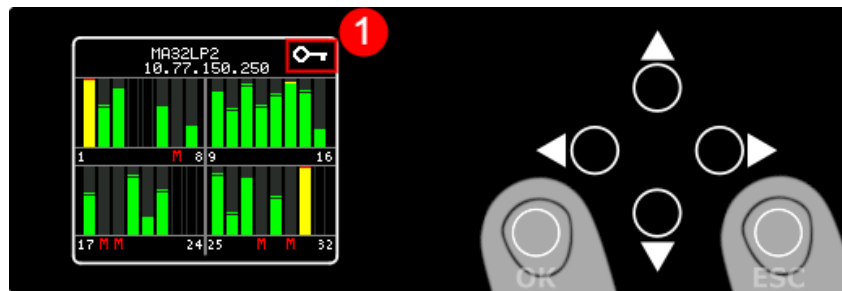

Figure 22. DEVICE LOCK

To enable and disable Display Device Lock, hold **OK** and **ESC** for about 2 seconds. The Device Lock prevents changing the IP settings on display. The small Key ① shows activated Device Lock on every Page.

3.3.2. POWER LED

See [② FRONT VIEW](#)

Table 7. POWER LED states

COLOR	DESCRIPTION
GREEN	everything is ok
ORANGE	system is booting up
RED	one or more channels are in error state

3.3.3. WEBSITE

To get to the website, open the IP or open the mDNS name. The website is the main User Interface to control every setting and get status informations of the amplifier.



Some DSP function and inputs are optional and depend on the software and hardware options of the device.



In single edit, value fields and buttons with blue background indicate the value is changed but not currently set to the device. In multi-edit it also indicates different values on the selected channel.

HEADER

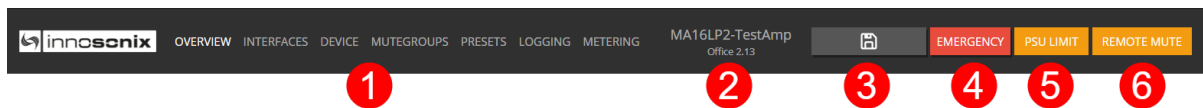

NR	DESCRIPTION	REFERENCE
1	navigate through pages	PAGES
2	click to change hostname or location	
3	save button / autosave status	SAVE INTERNAL STORAGE
4	overall amp status	AMP STATUS
5	PSU Limit indication	PSU LIMIT
6	Remote Mute active indication	DEVICE

PAGES

See [1](#) on [WEBPAGE HEADER](#)

Table 8. PAGES

IDENTIFIER	DESCRIPTION	REFERENCE
OVERVIEW	status and settings of amp channel	OVERVIEW
INTERFACES	device interface status and config	INTERFACES
DEVICE	device specific settings	DEVICE
MUTEGROUPS	mutegroup settings	MUTEGROUPS
PRESETS	device/channel preset edit/save/call/store	PRESETS
LOGGING	syslog with syslog server settings	LOGGING
METERING	show input / output level and measured voltage / current / power	METERING

SAVE INTERNAL STORAGE



After changing a setting, the auto save triggers, so all settings will be saved automatically after ten seconds.

If you click on [WEBPAGE HEADER 3](#), the save process will be triggered manually, so the amplifier saves all current settings to load at the next startup.

PSU LIMIT

If maximum power of the PSU is reached, the amplifier reduces the output with an extra limiter, to avoid shutting down the amplifier. The indicator LED ([WEBPAGE HEADER 5](#)) starts blinking, if reduction is active. To see the actual reduction value and load, see [DEVICE 4](#)

AMP STATUS

The Amp Status shows all currently applicable errors. To see the chronological sequence of errors see [LOGGING](#).

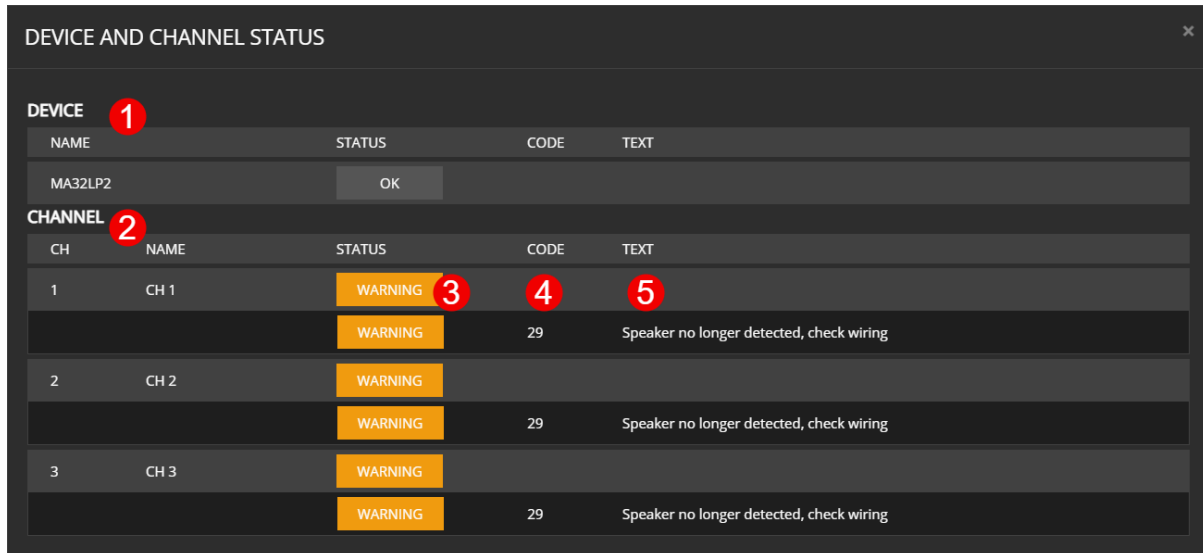

DEVICE AND CHANNEL STATUS				
DEVICE 1				
NAME	STATUS	CODE	TEXT	
MA32LP2	OK			
CHANNEL 2				
CH	NAME	STATUS	CODE	TEXT
1	CH 1	WARNING 3	4 29	5 Speaker no longer detected, check wiring
2	CH 2	WARNING	29	Speaker no longer detected, check wiring
3	CH 3	WARNING	29	Speaker no longer detected, check wiring

NR	DESCRIPTION	REFERENCE
1	device errors	
2	channel errors	
3	severity level	SEVERITY LEVEL
4	error code	ERROR CODES
5	error text	

FOOTER

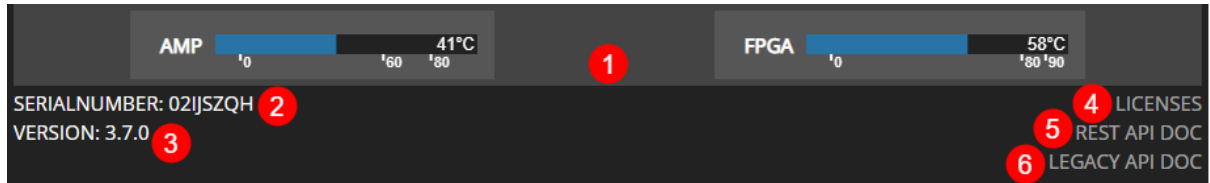

NR	DESCRIPTION	REFERENCE
1	Amp and FPGA temperatures (at 80°C the Amplifier executes emergency shutdown)	
2	device serial number	
3	software version	
4	navigate to license page	
5	navigate to rest api doc	RESTful API
6	navigate to legacy api doc	

OVERVIEW

All channel setting can be done to single and multi-channel (see [SELECTION AND GROUPING](#) for multi-channel selection details).

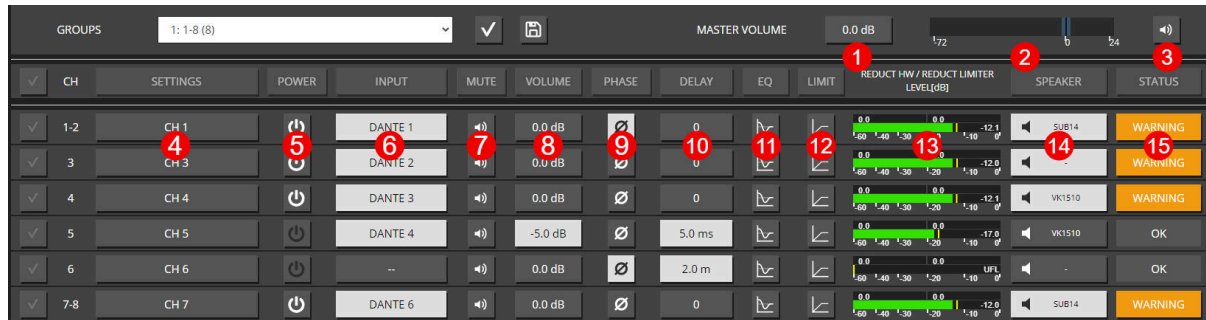

NR	DESCRIPTION	REFERENCE
1	click to set master volume	
2	change master volume by moving the slider	
3	click to toggle master mute	
4	click opens channel settings modal	CHANNEL SETTINGS
5	click to toggle amplifier power	CHANNEL POWER
6	click opens input patching modal (Σ indicates, that multiple inputs are set)	CHANNEL INPUT
7	click to toggle channel mute (blinks if muted by mutegroup MUTEGROUPS)	CHANNEL MUTE
8	click opens channel volume modal	CHANNEL VOLUME
9	click to toggle channel phase (reverses phase)	CHANNEL PHASE
10	click opens channel delay modal	CHANNEL DELAY
11	click opens channel eq modal	CHANNEL EQ
12	click opens channel limiter modal	CHANNEL LIMIT
13	sample synchronous channel level after processing, hw limiter (sum of PSU Limit and Thermo Limit) and biggest limiter reduction	
14	click opens channel speaker settings modal	CHANNEL SPEAKER SETTINGS
15	if error occurs, click opens channel status modal	error shown like AMP STATUS

SELECTION AND GROUPING

Multiple channels can be selected by clicking on . This feature enables the "multi-channel edit" functionality indicated by the active headline buttons (SETTINGS, POWER, ...). The headline buttons open the corresponding modal.



The saved selection groups will be used as mute groups **MUTEGROUPS** and can be selected in the channel edit modal header **MODAL HEADER**.

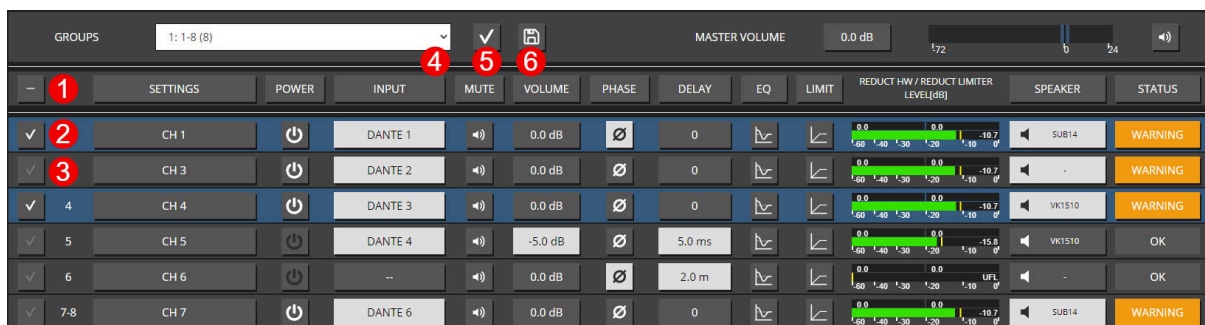
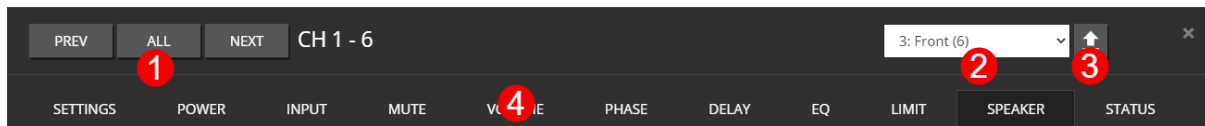

Figure 23. WEBPAGE GROUPING

NR	DESCRIPTION
1	Select/deselect all channels.
2	Channel is selected. Indicators are the white hook and the blue background of the channel line.
3	Channel is not selected.
4	Channel Groups drop-down list.
5	Loads the selected group to the selection.
6	Saves active selection to the selected group.

MODAL HEADER



NR	DESCRIPTION
1	Shows the current selected channels. The "PREV / ALL / NEXT" allows cycling through the selected channels to allow an easy single channel edit.
2	Select a selection group. (see. SELECTION AND GROUPING)
3	Loads the selected group to the selection.
4	Settings for the selected channels.

CHANNEL SETTINGS

CHANNEL NAME

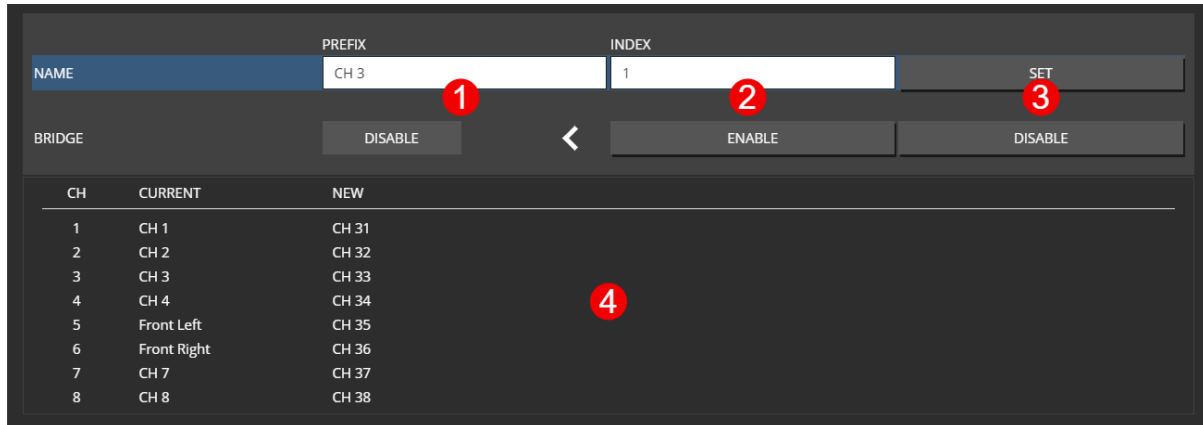

CH	CURRENT	NEW
1	CH 1	CH 31
2	CH 2	CH 32
3	CH 3	CH 33
4	CH 4	CH 34
5	Front Left	CH 35
6	Front Right	CH 36
7	CH 7	CH 37
8	CH 8	CH 38

NR	DESCRIPTION
1	Set channel prefix, which will be concatenated with the "INDEX" as final channel name.
2	Set an optional index which is incremented for each selected channel. (only available in multi-edit)
3	Execute changes.
4	Preview of channel names.

BRIDGE MODE

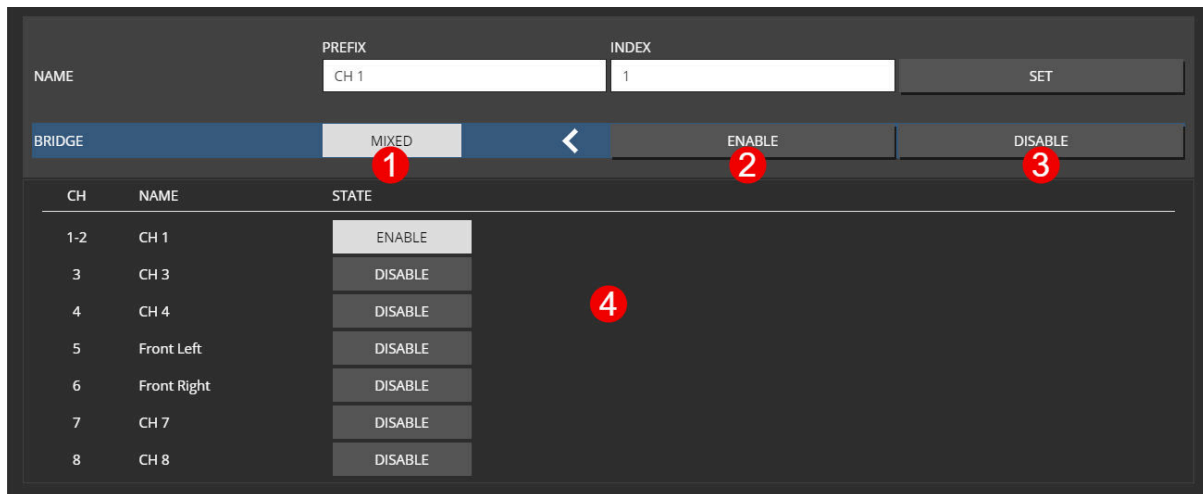

CH	NAME	STATE
1-2	CH 1	ENABLE
3	CH 3	DISABLE
4	CH 4	DISABLE
5	Front Left	DISABLE
6	Front Right	DISABLE
7	CH 7	DISABLE
8	CH 8	DISABLE

NR	DESCRIPTION
1	Indicates summarized state of selected channels.
2	Enable bridge mode for selected channels.
3	Disable bridge mode for selected channels.
4	States for all selected channels.



Only adjacent channel pairs can be set to bridge mode, channel 1/2 or 3/4

...



Enabling the **BRIDGE MODE** for a channel pair will clear all settings of the EVEN channel.

CHANNEL POWER



Power-off a channel will stop the class-d amp from switching to save idle power.

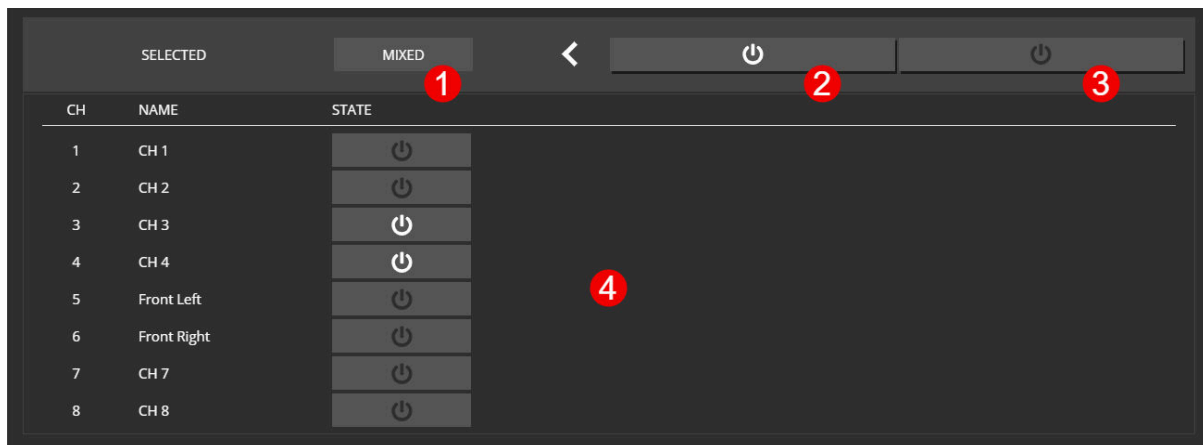

NR	DESCRIPTION
1	Indicates summarized state of selected channel.
2	Activate all selected channels.
3	Deactivate all selected channels.
4	States for all selected channels.

CHANNEL INPUT

Each DSP channel has its own 16x1 input mixer which allows a summation of up to 16 different sources with individual gains.

SINGLE CHANNEL

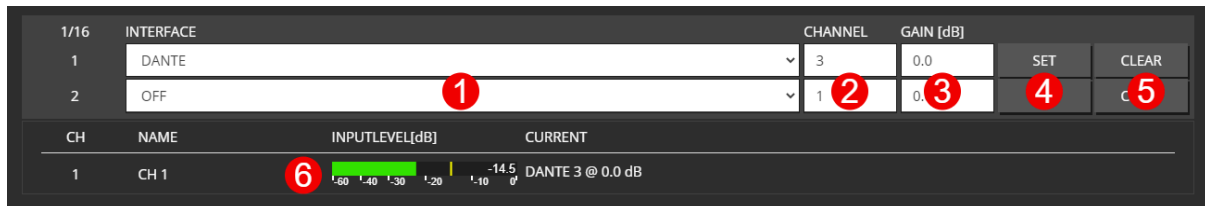

The screenshot shows a control interface for channel input. At the top, there is a table with columns: 1/16, INTERFACE, CHANNEL, and GAIN [dB]. Below this is a mixer output level indicator with a scale from -60 to 0 dB.

1/16	INTERFACE	CHANNEL	GAIN [dB]	SET	CLEAR
1	DANTE	3	0.0		
2	OFF	1	0.		

CH	NAME	INPUTLEVEL[dB]	CURRENT
1	CH 1	-14.5	DANTE 3 @ 0.0 dB

NR	DESCRIPTION
1	Select a input interface or test tone (depends on your hard- and software-options).
2	Select channel of interface type.
3	Gain for the selected source channel.
4	Sets slected parameters.
5	Remove the patch in the input mixer.
6	Mixer output level.

If you set the last slot, a new input slot appears till the maximum of 16 slots is reached.

MULTI CHANNEL

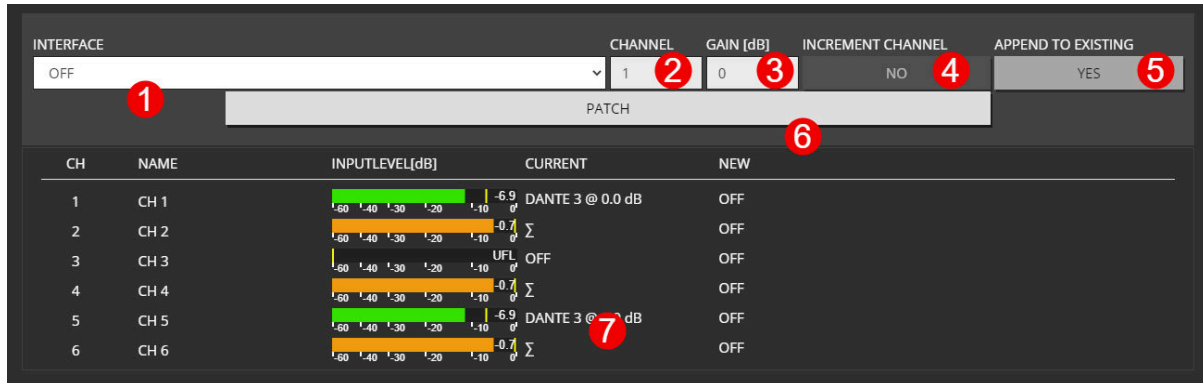

CH	NAME	INPUTLEVEL[dB]	CURRENT	NEW
1	CH 1	-6.9	DANTE 3 @ 0.0 dB	OFF
2	CH 2	-0.7	Σ	OFF
3	CH 3	UFL	OFF	OFF
4	CH 4	-0.7	Σ	OFF
5	CH 5	-6.9	DANTE 3 @ 0.0 dB	OFF
6	CH 6	-0.7	Σ	OFF

NR	DESCRIPTION
1	Select a input interface or test tone (depends on your hard- and software-options).
2	Select channel of interface type.
3	Gain for the selected source channel.
4	Increments input channel through patch.
5	Appends selected patching to existing patches on the channels.
6	Execute the patch command.
7	Preview of selected combination.



Σ indicates, that multiple inputs are set.

CHANNEL MUTE

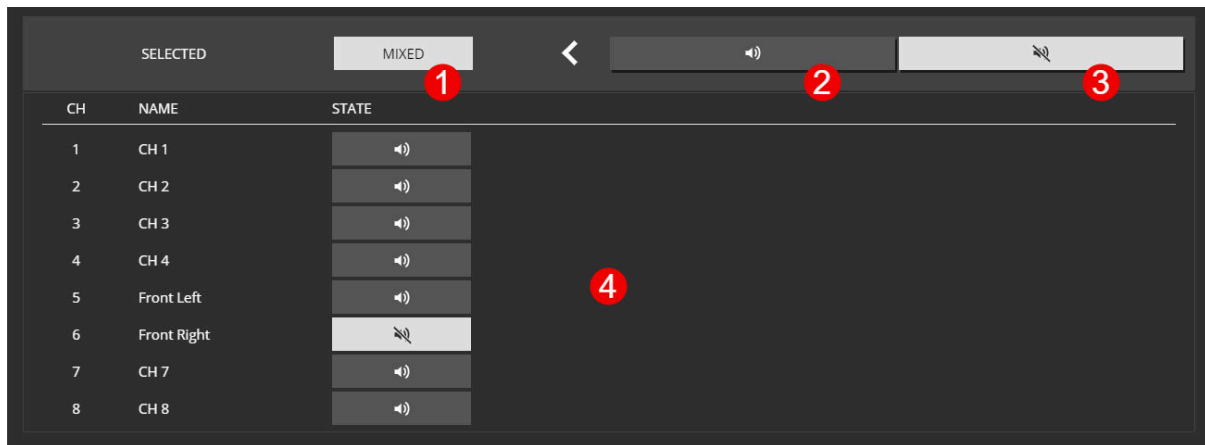

NR	DESCRIPTION
1	Indicates summarized state of selected channels.
2	Unmutes all selected channels.
3	Mutes all selected channels.
4	Shows states of all selected channels.

CHANNEL VOLUME

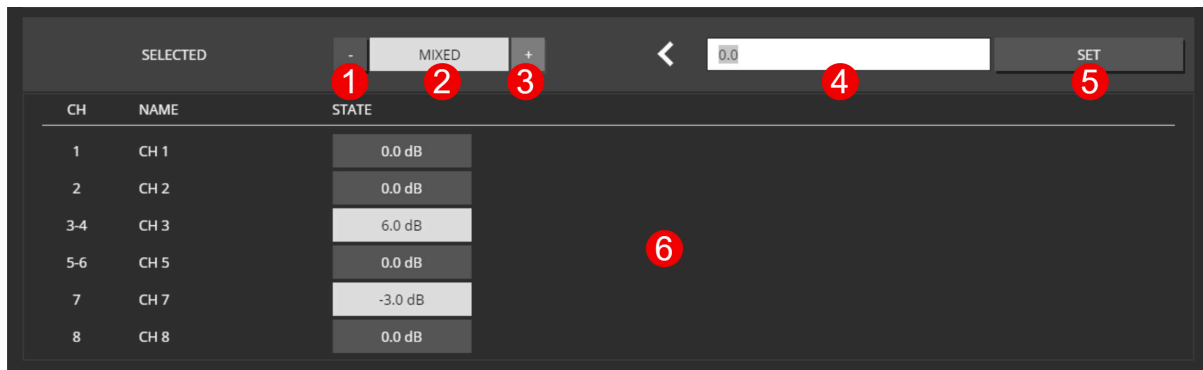

NR	DESCRIPTION
1	Decreases volume of selected channels by 1 dB.
2	Indicates summarized the state of selected channels.
3	Increases volume of selected channels by 1 dB.
4	Channel volume to set.
5	Apply Settings.
6	Shows vales of selected channels.

CHANNEL PHASE

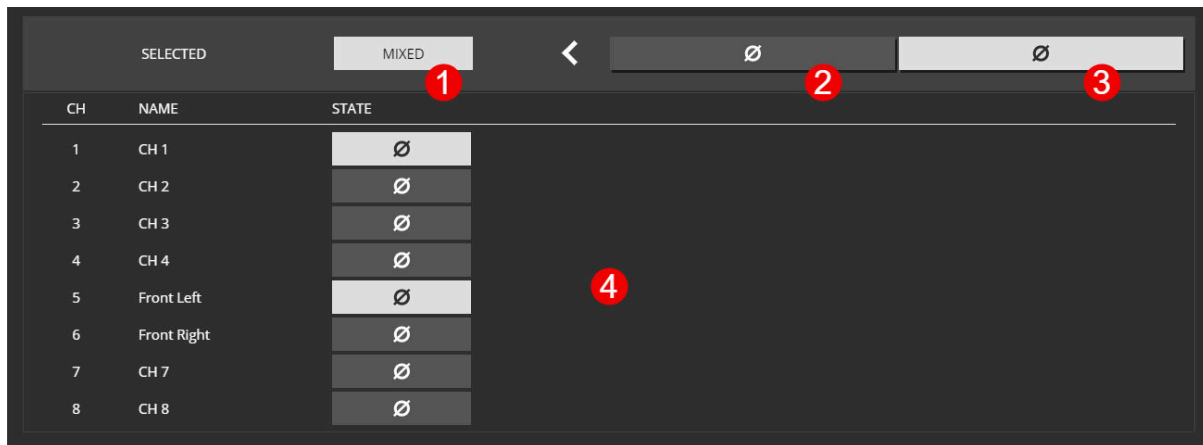

NR	DESCRIPTION
1	Indicates summarized state of selected channels.
2	Set normal phase.
3	Set reverse phase.
4	Shows vales of selected channels.

CHANNEL DELAY

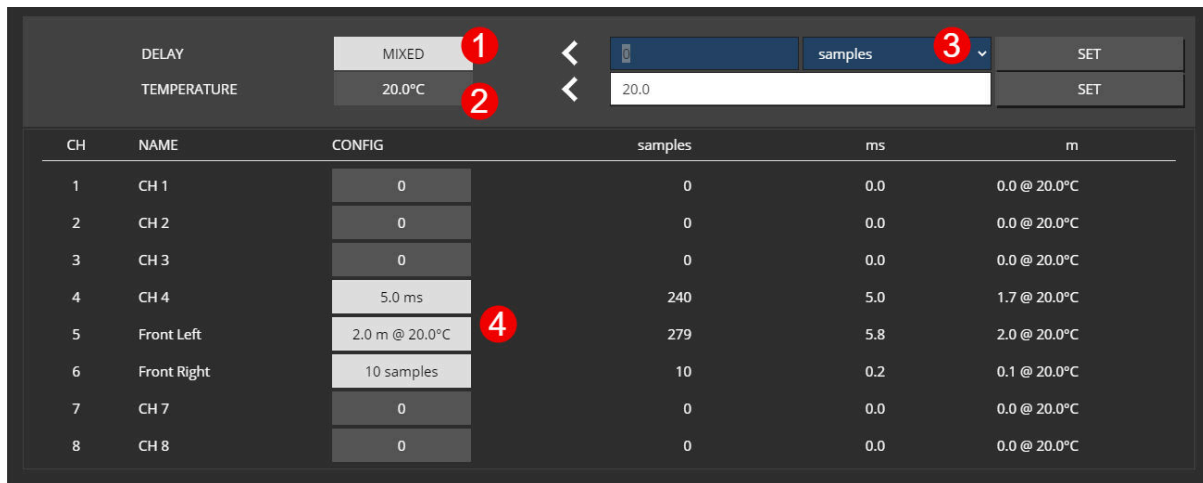

CH	NAME	CONFIG	samples	ms	m
1	CH 1	0	0	0.0	0.0 @ 20.0°C
2	CH 2	0	0	0.0	0.0 @ 20.0°C
3	CH 3	0	0	0.0	0.0 @ 20.0°C
4	CH 4	5.0 ms	240	5.0	1.7 @ 20.0°C
5	Front Left	2.0 m @ 20.0°C	279	5.8	2.0 @ 20.0°C
6	Front Right	10 samples	10	0.2	0.1 @ 20.0°C
7	CH 7	0	0	0.0	0.0 @ 20.0°C
8	CH 8	0	0	0.0	0.0 @ 20.0°C

NR	DESCRIPTION
----	-------------

- | | |
|---|---|
| 1 | Indicates summarized delay of selected channels. |
| 2 | When setting the delay in meters, an air temperature has to be specified to calculate the speed of sound. |
| 3 | Delay can be set in different units, like samples, meters, milliseconds. |
| 4 | Shows vales of selected channels. |



The values for ms and m will be calculated with given temperature and/or samplingrate. The result will be round to samples. 4 show calced value.

CHANNEL EQ

PEQ



There are 32 EQ slots that can be set with several EQ types. Some EQ types need more than one EQ slot. 18dB/24dB Low/High passes require two, while 48dB Low/High require four slots.



When values are changed but not set to the device, the EQ is in preview mode **2**, and the PEQ plot only shows the theoretical EQ curve. The current enabled EQs are plotted in the output curve.



The screenshot shows the PEQ (Parametric EQ) interface in 'PREVIEW' mode. The top bar includes a 'Fullscreen' button (1), the 'PREVIEW' status (2), and two plot buttons: 'PLOT PEQ' (3) and 'PLOT ADVANCED EQ' (4). The main plot area shows a frequency response curve from 20Hz to 20kHz. A blue curve (5) represents the selected EQ, showing a peak at 102Hz. A green shaded area represents the output curve. Below the plot is a table of EQ settings (6) for EQ 1 through EQ 11. EQ 1 is selected and shows a peak at 102Hz with a gain of 10.8dB (7). EQ 2-5 are set to 'LP 48dB LW-R' with a frequency of 1.73k. EQ 6-11 are set to 'PEAK' with various frequencies and gains. A 'SET' button is visible for each EQ slot. At the bottom, a table (8) lists the current settings for all EQ slots across different channels.

EQ	TYPE	FREQ [Hz]	GAIN [dB]	QUAL
EQ 1	PEAK	102	10.8	3.1
EQ 2-5	LP 48dB LW-R	1.73k	0.0	1.0
EQ 6	PEAK	63	0.0	1.0
EQ 7	PEAK	80	0.0	1.0
EQ 8	PEAK	100	0.0	1.0
EQ 9	PEAK	100	0.0	1.0
EQ 10	PEAK	100	0.0	1.0
EQ 11	PEAK	100	0.0	1.0

CH	NAME	TYPE	ENABLE	GAIN [dB]	FREQUENCY [Hz]	QUALITY
1	Front R	PEAK	ON	10.8	102	2.5
2	Front L	PEAK	ON	10.8	102	2.5
3	Rear R	PEAK	ON	10.8	102	2.5
4	Rear L	PEAK	ON	10.8	102	2.5
5	Center	PEAK	ON	10.8	102	2.5
6	Sub R	PEAK	ON	10.8	102	2.5
7	Sub L	PEAK	ON	10.8	102	2.5
8	Surround R	PEAK	ON	10.8	102	2.5

NR	DESCRIPTION
1	Enables fullscreen mode.
2	Toggle visibility of peq sum plot.
3	Toggle visibility of advanced eq plot.
4	Indicates preview mode.
5	Drag the grab point with the mouse to change frequency/gain, use the mouse wheel to change the quality.
6	Switch between the PEQ / ADVANCED EQ settings.
7	Edit / shows the parameter of all EQs.
8	Multi-edit values for all selected channels.

PEQ FULLSCREEN



NR	DESCRIPTION
1	Toggle toolbox view.
2	Edit / shows the parameter of the selected EQ slot.
3	Drag the grab point with the mouse to change frequency/gain, use the mouse wheel to change the quality.

ADVANCED EQ (FIR)

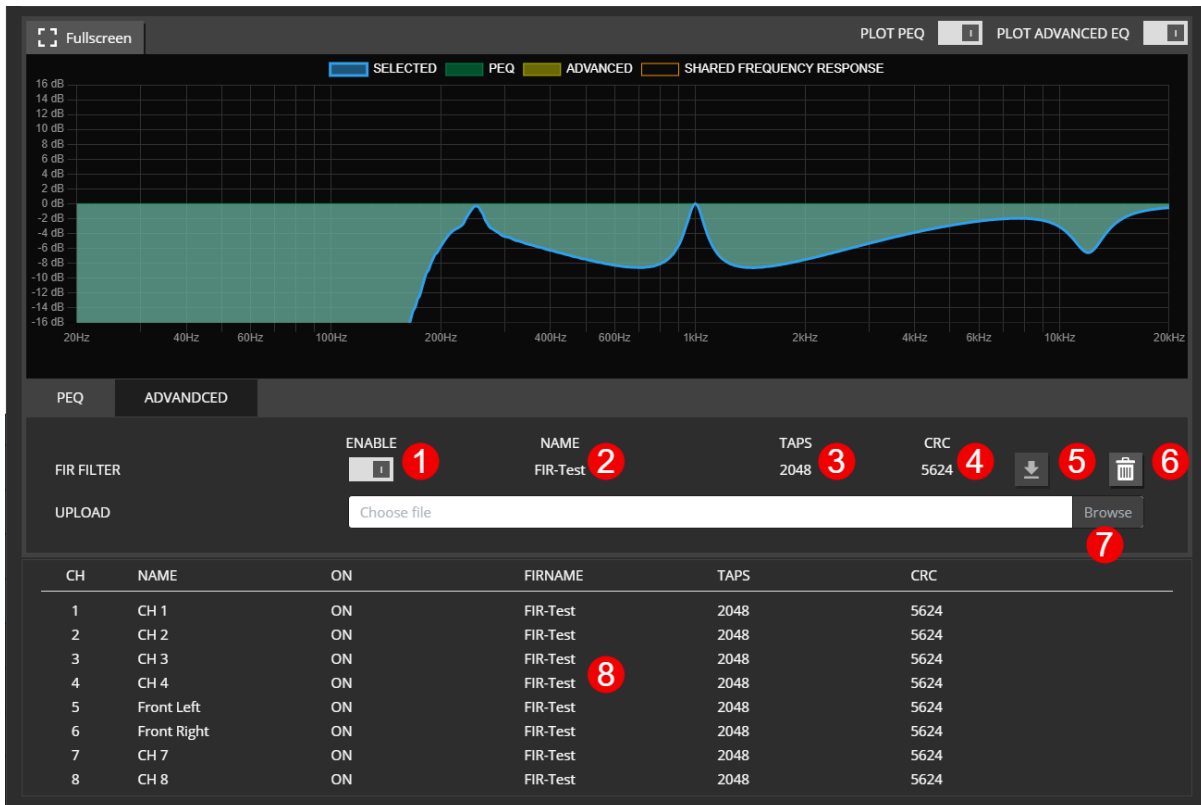

NR DESCRIPTION

- 1 Enable/disable the FIR filter on the selected channel.
- 2 Name of the loaded FIR filter.
- 3 Taps of the loaded FIR filter.
- 4 Internal calculated CRC over the fixed point coefficients to indicate even single bit differences in the loaded filters.
- 5 Download the selected FIR (only available on single edit)
- 6 Delete FIR filter.
- 7 Upload a FIR filter to the selected channels (a preview modal appears to check the filter)
- 8 Details of all selected channels.

CHANNEL LIMIT

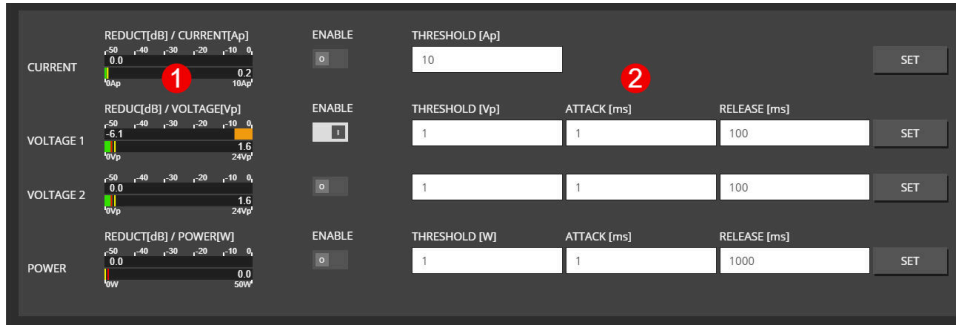

REDUCT[dB] / CURRENT[Ap] ENABLE THRESHOLD [Ap]

CURRENT 0.0 0.2 10

REDUCT[dB] / VOLTAGE[Vp] ENABLE THRESHOLD [Vp] ATTACK [ms] RELEASE [ms]

VOLTAGE 1 -6.1 1.6 24Vp 1 1 100 SET

VOLTAGE 2 0.0 1.6 24Vp 0 1 100 SET

REDUCT[dB] / POWER[W] ENABLE THRESHOLD [W] ATTACK [ms] RELEASE [ms]

POWER 0.0 50W 1 1 1000 SET

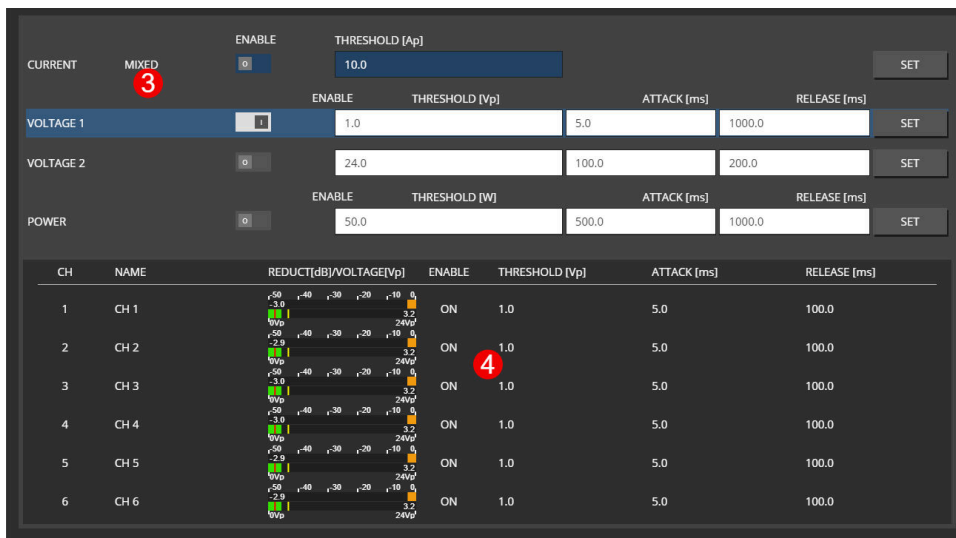

CURRENT MIXED ENABLE THRESHOLD [Ap]

10.0 SET

VOLTAGE 1 1 1.0 5.0 1000.0 SET

VOLTAGE 2 0 24.0 100.0 200.0 SET

POWER 0 50.0 500.0 1000.0 SET

CH	NAME	REDUCT[dB]/VOLTAGE[Vp]	ENABLE	THRESHOLD [Vp]	ATTACK [ms]	RELEASE [ms]
1	CH 1	-3.0	ON	1.0	5.0	100.0
2	CH 2	-2.9	ON	1.0	5.0	100.0
3	CH 3	-3.0	ON	1.0	5.0	100.0
4	CH 4	-3.0	ON	1.0	5.0	100.0
5	CH 5	-2.9	ON	1.0	5.0	100.0
6	CH 6	-2.9	ON	1.0	5.0	100.0

NR DESCRIPTION

- 1 Shows reduction and measured input level (Vp, Ap, or W) of each limiter.
- 2 Set threshold attack and release of individual limiter.
- 3 Reduction level disabled in multi-edit, each limiter can be selected and is highlighted by the blue line.
- 4 Shows limiter values of the selected limiter and selected channels.



Disabled limiters are set to the maximum threshold internally. Due to the internal headroom, it is still possible to see some reduction if the maximum thresholds are reached.

CHANNEL SPEAKER SETTINGS

SINGLE EDIT

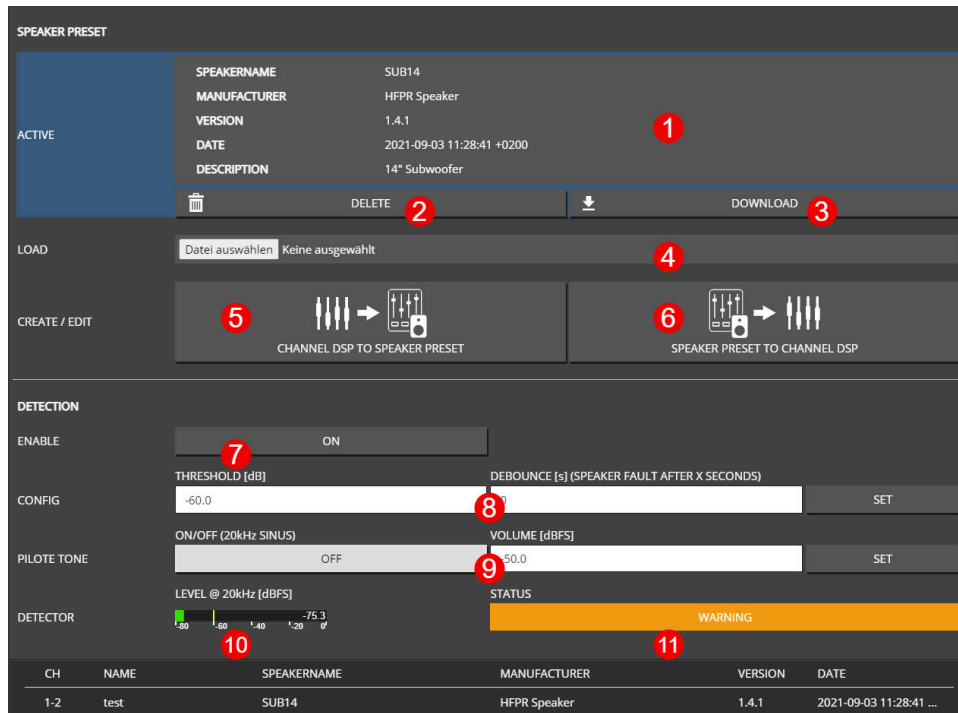

Figure 24. SPEAKER SINGLE CHANNEL EDIT VIEW

NR	DESCRIPTION
1	Metadata of the active speaker preset.
2	Remove the speaker preset.
3	Download the speaker preset file to share it or apply to others channels.
4	Load a speaker preset file from your computer.
5	Create a speaker preset from channel dsp data WEBPAGE SPEAKER PRESET CREATE .
6	Load the speaker preset dsp data to the channel dsp WEBPAGE SPEAKER PRESET LOAD .
7	Enable/Disable speaker detection.
8	Set detection threshold and debounce. The 20 kHz current value has to be lower than the threshold for "debounce" seconds to trigger an error.
9	Set 20 kHz pilot tone generator level in dBFS which will be added to the actual output signal of the amplifier.
10	Shows measured current at 20 kHz (yellow line indicates threshold)
11	Shows actual speaker detection status.

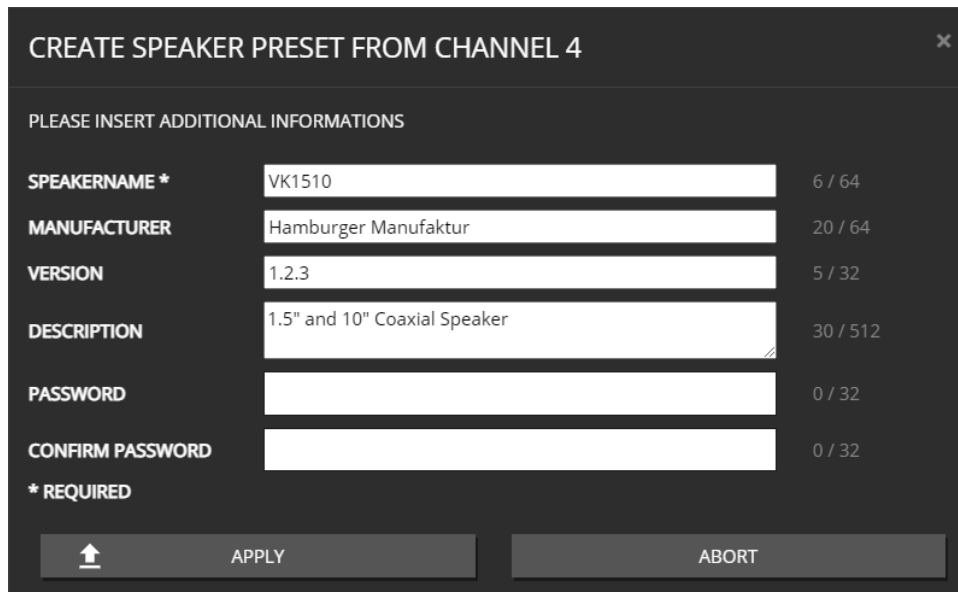

Figure 25. WEBPAGE SPEAKER PRESET CREATE

To create a speaker preset, tune your speaker with the channel DSP settings to your needs. The parameter which can be used inside the speaker preset are: VOLUME, PHASE, DELAY, 32x PEQ, ADVANCED EQ (FIR Filters with 512 Taps), LIMIT.

Once happy with your parameter work, create the speaker preset by clicking on the "CHANNEL DSP TO SPEAKER PRESET" button. This will copy all parameters listed above to a fully separated "SPEAKER DSP" and free up the "CHANNEL DSP".

Information like a speaker name is mandatory, all other parameters are optional. If the data have to be secure, please insert a password. This password is only required to load the speaker preset to the channel DSP (for further editing).



The FIR Filter in the speaker preset can only have 512 taps, instead of the full 2048 taps which are possible in the channel DSP.



The LIMIT section only exists once. If a limiter is used inside a speaker preset, it will just block that specific limiter from being used by the user.

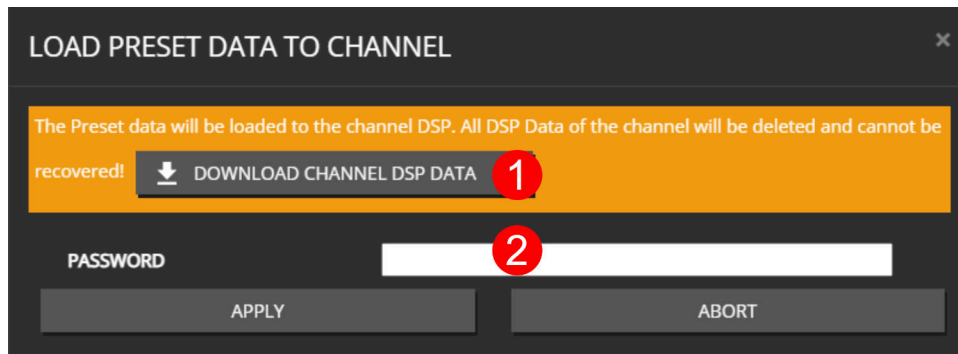

Figure 26. WEBPAGE SPEAKER PRESET LOAD

NR	DESCRIPTION
1	Since the channel DSP will be overwritten by the speaker preset values, a backup of the currently loaded settings can be downloaded as channel preset.
2	If a speaker preset is created with a password, the password is required to load the data to the channel

MULTI EDIT

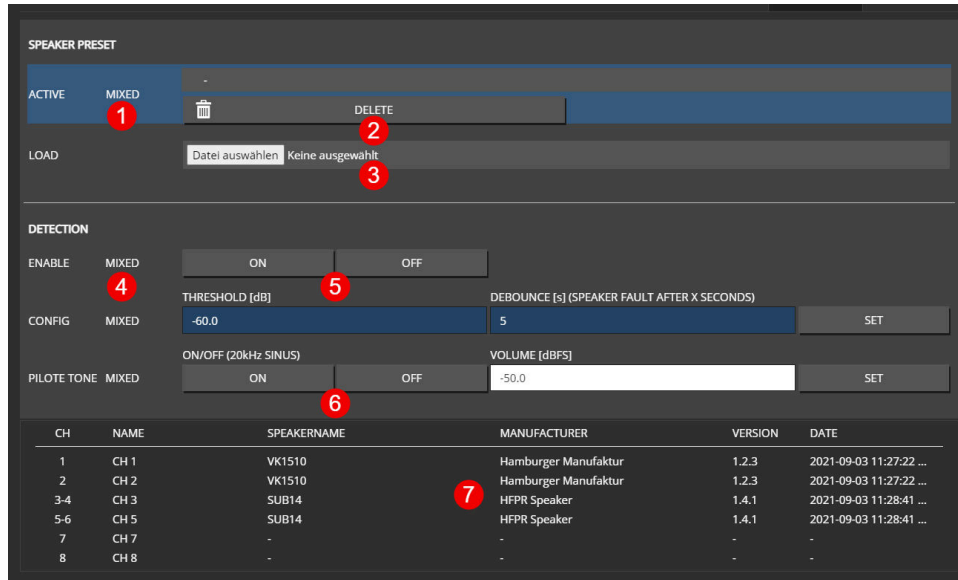

Figure 27. SPEAKER MULTI CHANNEL EDIT VIEW

NR	DESCRIPTION
1	Mixed speaker preset indicator (different speakers presets are loaded on the selected channel)
2	Delete the currently loaded speaker preset from all selected channels.
3	Load a speaker preset file from your computer to all selected channels.
4	Mixed value indicator of the speaker detection section.
5	Enable/Disable speaker detection.
6	Set 20 kHz pilot tone generator level in dBFS which will be added to the actual output signal of the amplifier.
7	Shows actual speaker detection status.

INTERFACES

INTERFACE STATUS				
SYNC SELECT	NAME	STATUS	SAMPLINGRATE	CHANNEL
<input type="radio"/>	MADI FIBRE	unlock	-	-
<input type="radio"/>	MADI COAX 1	unlock	-	-
<input type="radio"/>	MADI COAX 2	unlock	-	-
<input checked="" type="radio"/>	DANTE	sync	48kHz	32
<input type="radio"/>	AES3 1 (ASRC)	unlock	-	-
<input type="radio"/>	AES3 2 (ASRC)	unlock	-	-
DIRECT MADI FIBRE OUTPUT				
INTERNAL TX				
INTERNAL MADI FIBRE/DANTE OUTPUT				
CURRENT OUT (Ch. 1 - 32)				

Figure 28. WEBPAGE INTERFACES

NR	DESCRIPTION
1	Select an interface to synchronize the internal audio word clock generation.
2	Interface name.
3	Interface status see. SYNC STATUS
4	Sampling rate.
5	Available channel on this interface.
6	Select the source of the MADI FIBRE TX jack. This can either be "INTERNAL TX" which uses the internal MADI transmitter, or any of the other MADI RX jacks. In the case of an RX jack, the connection is direct routed through the FPGA with almost zero latency, but a jitter build-up has to be in mind. The direct through connection can be used to daisy-chain two devices to utilize all 64 channels on a MADI signal. Device 1 consumes CH1-32, device 2 CH33-64.
7	Selects a pre-defined output routing of the internal MADI TX / DANTE TX transmitter, see OUTPUT PRESETS .

SYNC STATUS

STATUS	DESCRIPTION
unlock	No valid carrier or word-clock was detected on that interface.
lock	Valid carrier and word-clock but not in phase with the internal audio clock.
sync	Valid carrier and word-clock AND in phase with the internal audio clock.
error	Unsupported sample rate.

OUTPUT PRESETS



Channel assignments on MADI TX and Dante TX are the same.

available Output presets

OFF

MADI FIBRE (Ch. 1 - 64)

MADI FIBRE (Ch. 33 - 64)

MADI COAX 1 (Ch. 1 - 64)

MADI COAX 1 (Ch. 33 - 64)

MADI COAX 2 (Ch. 1 - 64)

MADI COAX 2 (Ch. 33 - 64)

DANTE (Ch. 1 - 32)

DSP OUT (Ch. 1 - 32)

CURRENT OUT (Ch. 1 - 32)

VOLTAGE OUT (Ch. 1 - 32)

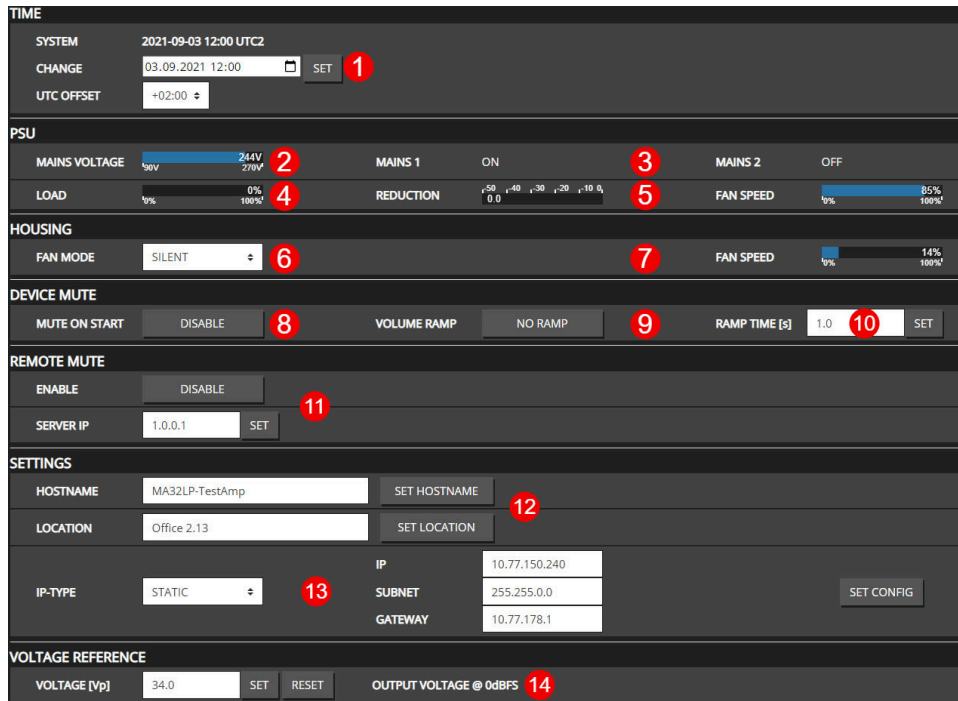
DEVICE

The screenshot shows a web interface for configuring a device. It is divided into several sections: TIME, PSU, HOUSING, DEVICE MUTE, REMOTE MUTE, SETTINGS, and VOLTAGE REFERENCE. Red circles with numbers 1 through 14 point to specific configuration elements across these sections.

NR	DESCRIPTION
1	Set system time and time zone. If the device is connected to the internet, it will try to synchronize its RTC (real time clock) to an NTP time-server.
2	Shows measured mains voltage if the device does support it. If not, the user has to configure the current mains voltage which is required for the PSU limiting.
3	If the device has more than one PSU, it will indicate which one is plugged in. (HP ² only)
4	Shows PSU Load.
5	Shows PSU reduction, which will reduce the output level of all channels simultaneously to not overload the PSU.
6	FAN MODE "NORMAL" is the recommended mode to keep all components as cool as possible to improve lifetime. When not much output power is required, the FAN MODE could be changed to "SILENT" or "PASSIVE" (LP ² only) which will use different fan speeds to reduce noise.
7	Shows actual housing fan speed (depends on internal temperature).
8	En-/disable mute on startup, if enabled, the "MASTER MUTE" will be set on every start up.
9	En-/disable volume ramp after the master mute is disabled. This will linearly increase the dB value until it is reached its desired value.
10	Master Volume ramp-up-time in seconds, if enabled.
11	Enable remote mute, this will provide a GPI interface to mute the entire device, also known as dead man switch. Which require an external Innosonix Remote Mute Server, multiple devices can share one server.

12

The "HOSTNAME" is used in DNS for IP resolving. "LOCATION" is just a string to add some additional information to the device, like where is it located.

13

Set IP setting, this will disconnect the web page. Manually connect to the new IP or HOSTNAME in your browser.

14

"VOLTAGE REFERENCE" defines the maximal output peak-voltage when feeding an 0dBFS signal on any input interface. Due to different maximum rail voltages based on the hardware device, a clipping could occur.

MUTEGROUPS

Mute groups assignment are derived from selection groups ([SELECTION AND GROUPING](#)).

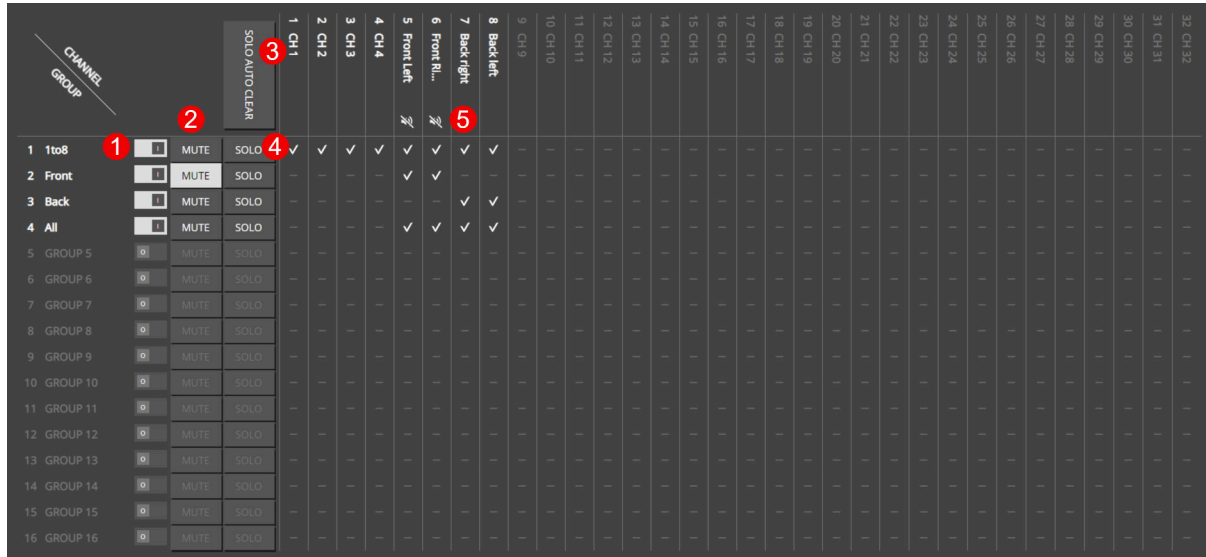

CHANNEL GROUP	SOLO AUTO CLEAR	1 CH 1	2 CH 2	3 CH 3	4 CH 4	5 FrontLeft	6 Front Rl...	7 Backright	8 Backleft	9 CH 9	10 CH 10	11 CH 11	12 CH 12	13 CH 13	14 CH 14	15 CH 15	16 CH 16	17 CH 17	18 CH 18	19 CH 19	20 CH 20	21 CH 21	22 CH 22	23 CH 23	24 CH 24	25 CH 25	26 CH 26	27 CH 27	28 CH 28	29 CH 29	30 CH 30	31 CH 31	32 CH 32
1 1to8	<input checked="" type="checkbox"/>	<input checked="" type="checkbox"/>	<input checked="" type="checkbox"/>	<input checked="" type="checkbox"/>	<input checked="" type="checkbox"/>	<input checked="" type="checkbox"/>	<input checked="" type="checkbox"/>	<input checked="" type="checkbox"/>	<input checked="" type="checkbox"/>	<input type="checkbox"/>	<input type="checkbox"/>	<input type="checkbox"/>	<input type="checkbox"/>	<input type="checkbox"/>	<input type="checkbox"/>	<input type="checkbox"/>	<input type="checkbox"/>	<input type="checkbox"/>	<input type="checkbox"/>	<input type="checkbox"/>	<input type="checkbox"/>	<input type="checkbox"/>	<input type="checkbox"/>	<input type="checkbox"/>	<input type="checkbox"/>	<input type="checkbox"/>	<input type="checkbox"/>	<input type="checkbox"/>	<input type="checkbox"/>	<input type="checkbox"/>	<input type="checkbox"/>	<input type="checkbox"/>	<input type="checkbox"/>
2 Front	<input type="checkbox"/>	<input type="checkbox"/>	<input type="checkbox"/>	<input type="checkbox"/>	<input type="checkbox"/>	<input type="checkbox"/>	<input type="checkbox"/>	<input type="checkbox"/>	<input type="checkbox"/>	<input type="checkbox"/>	<input type="checkbox"/>	<input type="checkbox"/>	<input type="checkbox"/>	<input type="checkbox"/>	<input type="checkbox"/>	<input type="checkbox"/>	<input type="checkbox"/>	<input type="checkbox"/>	<input type="checkbox"/>	<input type="checkbox"/>	<input type="checkbox"/>	<input type="checkbox"/>	<input type="checkbox"/>	<input type="checkbox"/>	<input type="checkbox"/>	<input type="checkbox"/>	<input type="checkbox"/>	<input type="checkbox"/>	<input type="checkbox"/>	<input type="checkbox"/>	<input type="checkbox"/>	<input type="checkbox"/>	<input type="checkbox"/>
3 Back	<input type="checkbox"/>	<input type="checkbox"/>	<input type="checkbox"/>	<input type="checkbox"/>	<input type="checkbox"/>	<input type="checkbox"/>	<input type="checkbox"/>	<input type="checkbox"/>	<input type="checkbox"/>	<input type="checkbox"/>	<input type="checkbox"/>	<input type="checkbox"/>	<input type="checkbox"/>	<input type="checkbox"/>	<input type="checkbox"/>	<input type="checkbox"/>	<input type="checkbox"/>	<input type="checkbox"/>	<input type="checkbox"/>	<input type="checkbox"/>	<input type="checkbox"/>	<input type="checkbox"/>	<input type="checkbox"/>	<input type="checkbox"/>	<input type="checkbox"/>	<input type="checkbox"/>	<input type="checkbox"/>	<input type="checkbox"/>	<input type="checkbox"/>	<input type="checkbox"/>	<input type="checkbox"/>	<input type="checkbox"/>	<input type="checkbox"/>
4 All	<input type="checkbox"/>	<input type="checkbox"/>	<input type="checkbox"/>	<input type="checkbox"/>	<input type="checkbox"/>	<input type="checkbox"/>	<input type="checkbox"/>	<input type="checkbox"/>	<input type="checkbox"/>	<input type="checkbox"/>	<input type="checkbox"/>	<input type="checkbox"/>	<input type="checkbox"/>	<input type="checkbox"/>	<input type="checkbox"/>	<input type="checkbox"/>	<input type="checkbox"/>	<input type="checkbox"/>	<input type="checkbox"/>	<input type="checkbox"/>	<input type="checkbox"/>	<input type="checkbox"/>	<input type="checkbox"/>	<input type="checkbox"/>	<input type="checkbox"/>	<input type="checkbox"/>	<input type="checkbox"/>	<input type="checkbox"/>	<input type="checkbox"/>	<input type="checkbox"/>	<input type="checkbox"/>	<input type="checkbox"/>	<input type="checkbox"/>
5 GROUP 5	<input type="checkbox"/>	<input type="checkbox"/>	<input type="checkbox"/>	<input type="checkbox"/>	<input type="checkbox"/>	<input type="checkbox"/>	<input type="checkbox"/>	<input type="checkbox"/>	<input type="checkbox"/>	<input type="checkbox"/>	<input type="checkbox"/>	<input type="checkbox"/>	<input type="checkbox"/>	<input type="checkbox"/>	<input type="checkbox"/>	<input type="checkbox"/>	<input type="checkbox"/>	<input type="checkbox"/>	<input type="checkbox"/>	<input type="checkbox"/>	<input type="checkbox"/>	<input type="checkbox"/>	<input type="checkbox"/>	<input type="checkbox"/>	<input type="checkbox"/>	<input type="checkbox"/>	<input type="checkbox"/>	<input type="checkbox"/>	<input type="checkbox"/>	<input type="checkbox"/>	<input type="checkbox"/>	<input type="checkbox"/>	<input type="checkbox"/>
6 GROUP 6	<input type="checkbox"/>	<input type="checkbox"/>	<input type="checkbox"/>	<input type="checkbox"/>	<input type="checkbox"/>	<input type="checkbox"/>	<input type="checkbox"/>	<input type="checkbox"/>	<input type="checkbox"/>	<input type="checkbox"/>	<input type="checkbox"/>	<input type="checkbox"/>	<input type="checkbox"/>	<input type="checkbox"/>	<input type="checkbox"/>	<input type="checkbox"/>	<input type="checkbox"/>	<input type="checkbox"/>	<input type="checkbox"/>	<input type="checkbox"/>	<input type="checkbox"/>	<input type="checkbox"/>	<input type="checkbox"/>	<input type="checkbox"/>	<input type="checkbox"/>	<input type="checkbox"/>	<input type="checkbox"/>	<input type="checkbox"/>	<input type="checkbox"/>	<input type="checkbox"/>	<input type="checkbox"/>	<input type="checkbox"/>	<input type="checkbox"/>
7 GROUP 7	<input type="checkbox"/>	<input type="checkbox"/>	<input type="checkbox"/>	<input type="checkbox"/>	<input type="checkbox"/>	<input type="checkbox"/>	<input type="checkbox"/>	<input type="checkbox"/>	<input type="checkbox"/>	<input type="checkbox"/>	<input type="checkbox"/>	<input type="checkbox"/>	<input type="checkbox"/>	<input type="checkbox"/>	<input type="checkbox"/>	<input type="checkbox"/>	<input type="checkbox"/>	<input type="checkbox"/>	<input type="checkbox"/>	<input type="checkbox"/>	<input type="checkbox"/>	<input type="checkbox"/>	<input type="checkbox"/>	<input type="checkbox"/>	<input type="checkbox"/>	<input type="checkbox"/>	<input type="checkbox"/>	<input type="checkbox"/>	<input type="checkbox"/>	<input type="checkbox"/>	<input type="checkbox"/>	<input type="checkbox"/>	<input type="checkbox"/>
8 GROUP 8	<input type="checkbox"/>	<input type="checkbox"/>	<input type="checkbox"/>	<input type="checkbox"/>	<input type="checkbox"/>	<input type="checkbox"/>	<input type="checkbox"/>	<input type="checkbox"/>	<input type="checkbox"/>	<input type="checkbox"/>	<input type="checkbox"/>	<input type="checkbox"/>	<input type="checkbox"/>	<input type="checkbox"/>	<input type="checkbox"/>	<input type="checkbox"/>	<input type="checkbox"/>	<input type="checkbox"/>	<input type="checkbox"/>	<input type="checkbox"/>	<input type="checkbox"/>	<input type="checkbox"/>	<input type="checkbox"/>	<input type="checkbox"/>	<input type="checkbox"/>	<input type="checkbox"/>	<input type="checkbox"/>	<input type="checkbox"/>	<input type="checkbox"/>	<input type="checkbox"/>	<input type="checkbox"/>	<input type="checkbox"/>	<input type="checkbox"/>
9 GROUP 9	<input type="checkbox"/>	<input type="checkbox"/>	<input type="checkbox"/>	<input type="checkbox"/>	<input type="checkbox"/>	<input type="checkbox"/>	<input type="checkbox"/>	<input type="checkbox"/>	<input type="checkbox"/>	<input type="checkbox"/>	<input type="checkbox"/>	<input type="checkbox"/>	<input type="checkbox"/>	<input type="checkbox"/>	<input type="checkbox"/>	<input type="checkbox"/>	<input type="checkbox"/>	<input type="checkbox"/>	<input type="checkbox"/>	<input type="checkbox"/>	<input type="checkbox"/>	<input type="checkbox"/>	<input type="checkbox"/>	<input type="checkbox"/>	<input type="checkbox"/>	<input type="checkbox"/>	<input type="checkbox"/>	<input type="checkbox"/>	<input type="checkbox"/>	<input type="checkbox"/>	<input type="checkbox"/>	<input type="checkbox"/>	<input type="checkbox"/>
10 GROUP 10	<input type="checkbox"/>	<input type="checkbox"/>	<input type="checkbox"/>	<input type="checkbox"/>	<input type="checkbox"/>	<input type="checkbox"/>	<input type="checkbox"/>	<input type="checkbox"/>	<input type="checkbox"/>	<input type="checkbox"/>	<input type="checkbox"/>	<input type="checkbox"/>	<input type="checkbox"/>	<input type="checkbox"/>	<input type="checkbox"/>	<input type="checkbox"/>	<input type="checkbox"/>	<input type="checkbox"/>	<input type="checkbox"/>	<input type="checkbox"/>	<input type="checkbox"/>	<input type="checkbox"/>	<input type="checkbox"/>	<input type="checkbox"/>	<input type="checkbox"/>	<input type="checkbox"/>	<input type="checkbox"/>	<input type="checkbox"/>	<input type="checkbox"/>	<input type="checkbox"/>	<input type="checkbox"/>	<input type="checkbox"/>	<input type="checkbox"/>
11 GROUP 11	<input type="checkbox"/>	<input type="checkbox"/>	<input type="checkbox"/>	<input type="checkbox"/>	<input type="checkbox"/>	<input type="checkbox"/>	<input type="checkbox"/>	<input type="checkbox"/>	<input type="checkbox"/>	<input type="checkbox"/>	<input type="checkbox"/>	<input type="checkbox"/>	<input type="checkbox"/>	<input type="checkbox"/>	<input type="checkbox"/>	<input type="checkbox"/>	<input type="checkbox"/>	<input type="checkbox"/>	<input type="checkbox"/>	<input type="checkbox"/>	<input type="checkbox"/>	<input type="checkbox"/>	<input type="checkbox"/>	<input type="checkbox"/>	<input type="checkbox"/>	<input type="checkbox"/>	<input type="checkbox"/>	<input type="checkbox"/>	<input type="checkbox"/>	<input type="checkbox"/>	<input type="checkbox"/>	<input type="checkbox"/>	<input type="checkbox"/>
12 GROUP 12	<input type="checkbox"/>	<input type="checkbox"/>	<input type="checkbox"/>	<input type="checkbox"/>	<input type="checkbox"/>	<input type="checkbox"/>	<input type="checkbox"/>	<input type="checkbox"/>	<input type="checkbox"/>	<input type="checkbox"/>	<input type="checkbox"/>	<input type="checkbox"/>	<input type="checkbox"/>	<input type="checkbox"/>	<input type="checkbox"/>	<input type="checkbox"/>	<input type="checkbox"/>	<input type="checkbox"/>	<input type="checkbox"/>	<input type="checkbox"/>	<input type="checkbox"/>	<input type="checkbox"/>	<input type="checkbox"/>	<input type="checkbox"/>	<input type="checkbox"/>	<input type="checkbox"/>	<input type="checkbox"/>	<input type="checkbox"/>	<input type="checkbox"/>	<input type="checkbox"/>	<input type="checkbox"/>	<input type="checkbox"/>	<input type="checkbox"/>
13 GROUP 13	<input type="checkbox"/>	<input type="checkbox"/>	<input type="checkbox"/>	<input type="checkbox"/>	<input type="checkbox"/>	<input type="checkbox"/>	<input type="checkbox"/>	<input type="checkbox"/>	<input type="checkbox"/>	<input type="checkbox"/>	<input type="checkbox"/>	<input type="checkbox"/>	<input type="checkbox"/>	<input type="checkbox"/>	<input type="checkbox"/>	<input type="checkbox"/>	<input type="checkbox"/>	<input type="checkbox"/>	<input type="checkbox"/>	<input type="checkbox"/>	<input type="checkbox"/>	<input type="checkbox"/>	<input type="checkbox"/>	<input type="checkbox"/>	<input type="checkbox"/>	<input type="checkbox"/>	<input type="checkbox"/>	<input type="checkbox"/>	<input type="checkbox"/>	<input type="checkbox"/>	<input type="checkbox"/>	<input type="checkbox"/>	<input type="checkbox"/>
14 GROUP 14	<input type="checkbox"/>	<input type="checkbox"/>	<input type="checkbox"/>	<input type="checkbox"/>	<input type="checkbox"/>	<input type="checkbox"/>	<input type="checkbox"/>	<input type="checkbox"/>	<input type="checkbox"/>	<input type="checkbox"/>	<input type="checkbox"/>	<input type="checkbox"/>	<input type="checkbox"/>	<input type="checkbox"/>	<input type="checkbox"/>	<input type="checkbox"/>	<input type="checkbox"/>	<input type="checkbox"/>	<input type="checkbox"/>	<input type="checkbox"/>	<input type="checkbox"/>	<input type="checkbox"/>	<input type="checkbox"/>	<input type="checkbox"/>	<input type="checkbox"/>	<input type="checkbox"/>	<input type="checkbox"/>	<input type="checkbox"/>	<input type="checkbox"/>	<input type="checkbox"/>	<input type="checkbox"/>	<input type="checkbox"/>	<input type="checkbox"/>
15 GROUP 15	<input type="checkbox"/>	<input type="checkbox"/>	<input type="checkbox"/>	<input type="checkbox"/>	<input type="checkbox"/>	<input type="checkbox"/>	<input type="checkbox"/>	<input type="checkbox"/>	<input type="checkbox"/>	<input type="checkbox"/>	<input type="checkbox"/>	<input type="checkbox"/>	<input type="checkbox"/>	<input type="checkbox"/>	<input type="checkbox"/>	<input type="checkbox"/>	<input type="checkbox"/>	<input type="checkbox"/>	<input type="checkbox"/>	<input type="checkbox"/>	<input type="checkbox"/>	<input type="checkbox"/>	<input type="checkbox"/>	<input type="checkbox"/>	<input type="checkbox"/>	<input type="checkbox"/>	<input type="checkbox"/>	<input type="checkbox"/>	<input type="checkbox"/>	<input type="checkbox"/>	<input type="checkbox"/>	<input type="checkbox"/>	<input type="checkbox"/>
16 GROUP 16	<input type="checkbox"/>	<input type="checkbox"/>	<input type="checkbox"/>	<input type="checkbox"/>	<input type="checkbox"/>	<input type="checkbox"/>	<input type="checkbox"/>	<input type="checkbox"/>	<input type="checkbox"/>	<input type="checkbox"/>	<input type="checkbox"/>	<input type="checkbox"/>	<input type="checkbox"/>	<input type="checkbox"/>	<input type="checkbox"/>	<input type="checkbox"/>	<input type="checkbox"/>	<input type="checkbox"/>	<input type="checkbox"/>	<input type="checkbox"/>	<input type="checkbox"/>	<input type="checkbox"/>	<input type="checkbox"/>	<input type="checkbox"/>	<input type="checkbox"/>	<input type="checkbox"/>	<input type="checkbox"/>	<input type="checkbox"/>	<input type="checkbox"/>	<input type="checkbox"/>	<input type="checkbox"/>	<input type="checkbox"/>	<input type="checkbox"/>

NR	DESCRIPTION
1	Only enabled mute groups are taken into account when the final mute result is calculated.
2	Mute / unmute mute group.
3	If solo auto clear is activated, only one solo can be active.
4	Active SOLO for the corresponding group. All other channels in an active mute group will be muted.
5	A speaker symbol and blinking MUTE button on the OVERVIEW indicates that the channel is muted due to a mute group assignment.

PRESETS

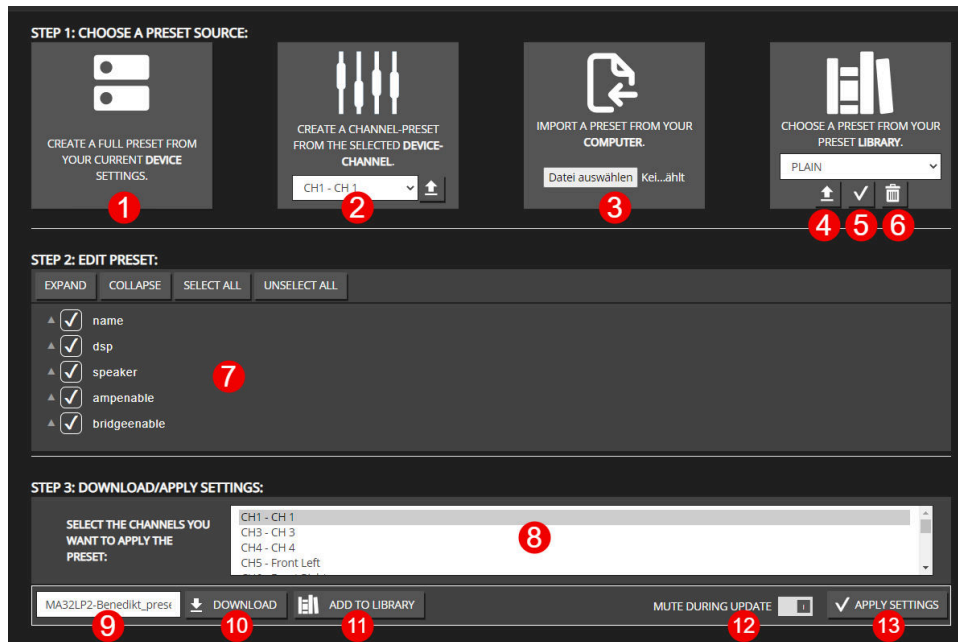

NR	DESCRIPTION
1	Load all device settings to the preset editor (7). Device presets do include fixed mapping of parameters to specific channels.
2	Load setting from one specific channel to preset editor (7).
3	Upload a file from your computer to the editor (7). It can either be a channel or device preset.
4	Load preset from preset library in preset editor (7).
5	Recall the selected preset from the library to the device. This functionality can also easily be triggered via the RESTful-API to do a simple scene switch.
6	Delete selected preset from the library.
7	edit settings tree
8	select (multiple) channel to load preset to (only available if channel preset is loaded into the preset editor)
9	preset name to save in library or download
10	save selected settings as preset to library
11	download selected settings as preset file
12	mute device / channel during update settings from preset
13	apply selected settings to device

LOGGING











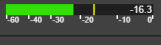
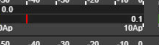
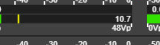
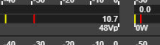
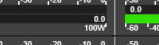



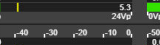

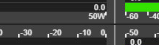



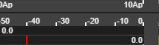
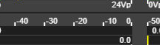

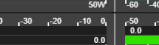
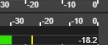



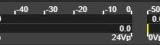
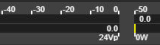
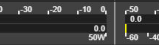
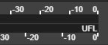

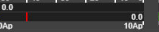
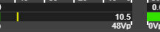
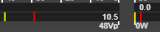
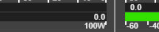
SYSLOG

TIME (YYYY-MM-DD hh:mm:ss)	SEVERITY	CATEGORY	MESSAGE
2021-03-30 17:26:51	warning	Channel 01 - CH 1	29 - Speaker no longer detected, check wiring
2021-03-30 17:26:48	informational	Device	01 - Power on with firmware: 3.3.2-16-g6f7b16f
2021-03-30 17:26:45	warning	Channel 03 - CH 3	29 - Speaker no longer detected, check wiring
2021-03-30 17:26:45	warning	Channel 02 - CH 2	29 - Speaker no longer detected, check wiring

REMOTE SYSLOG CONFIG

NR	DESCRIPTION
1	select syslog lines to load
2	refresh syslog table
3	export complete syslog from device
4	delete syslog files on the device
5	chronological errors
6	config connection to external syslog server

METERING

CH	NAME	INPUT	CURRENT	VOLTAGE 1	LIMITER	VOLTAGE 2	POWER	REDUCTION HARDWARE OUTPUT
1-2	CH 1							
3	CH 3							
4	CH 4							
5	CH 5							
6	CH 6							
7-8	CH 7							

NR	DESCRIPTION
1	input level after input mixer
2	measured current, voltage and power with limiter reductions
3	output level with hardware reduction (sum of PSU Limit and Thermo Limit)

3.3.4. ERROR CODES

Table 9. SEVERITY LEVEL

TYPE	DESCRIPTION
EMERGENCY	system is unusable
ALERT	action must be taken immediately
CRITICAL	critical conditions
ERROR	error conditions
WARNING	warning conditions
NOTICE	normal but significant condition
INFO	informational

Table 10. ERROR CODES

NR	SEVERITY	DESCRIPTION
1	INFO	Power on
2	INFO	IP mode set to DHCP
3	INFO	IP mode set to AUTO IP
4	INFO	IP mode set to STATIC IP
5	ALERT	UDP Discovery error, device no longer available, please try to restart the device
6	INFO	device reboots for software update
7	ALERT	Interfaces monitoring and control no longer available, please try to restart the device
8	ALERT	Speaker monitoring no longer available, please try to restart the device
9	ERROR	Display Interface no longer available, please try to restart the device
10	INFO	Samplingrate changed, EQs, Limiter, FIR Filter will be recalced
11	ALERT	DSP monitoring/control no longer available, please try to restart the device
12	EMERGENCY,	Hardware verification failed, no Audio available
13	ERROR	Metering no longer available, please try to restart the device
14	ERROR	Amplifier overcurrent error
15	ALERT	Amplifier overcurrent Shutdown
16	ALERT	Amplifier recurring overcurrent error, check wiring and powercycle channel to try again
17	EMERGENCY	Amplifier communication error, please try to restart the device
18	WARNING	Amplifier overtemp
19	ALERT	Controller monitoring no longer available, please try to restart the device

NR	SEVERITY	DESCRIPTION
20	ALERT	FAN controller no longer available, please try to restart the device
21	CRITICAL	Overtemp emergency shutdown init, all Fans will turn up, till temperature out of critical range
22	ALERT	PSU monitoring no longer available, please try to restart the device
23	ERROR	No settings file available ⇒ using default settings
24	ERROR	Settings file corrupted, file will be deleted
25	ALERT	All Settings files corrupted, start with default settings
26	ALERT	User Settings cannot be saved anymore, please try to restart the device
27	ALERT	User Settings cannot be changed anymore, please try to restart the device
28	ALERT	User Settings cannot be restored correctly, please try to restart the device
29	WARNING	Speaker no longer detected, check wiring
30	EMERGENCY	Wrong PD Type installed
31	ERROR	No Calibration File available, Amp using default values
32	CRITICAL	Power distribution overcurrent, try to restart
33	EMERGENCY	Amp Module Hardware Error
34	EMERGENCY	Amplifier Shutdown caused by PSU Overcurrent
35	ALERT	Remote Mute no longer available, please try to restart the device
36	EMERGENCY	Start without initing all Amps
37	ALERT	DC not OK
38	EMERGENCY	Amplifier Shutdown caused by overtemp emergency shutdown
39	EMERGENCY	Power Distribution cannot be load, please try to restart the device
40	WARNING	Link unlock
41	WARNING	CRC errors
42	WARNING	Negative Rail Converter ready timeout
43	WARNING	Fan dirty or stuck, check logging for further informations
44	WARNING	Fan dirty, please clean Fan
45	ALERT	Fan stuck, please check Fan
46	EMERGENCY	Amplifier Shutdown caused by dc protection
47	CRITICAL	Amplifier Shutdown caused by overtemperature
48	WARNING	Switching Frequency Error (Channel will be restarted)
49	EMERGENCY	PSU Shutdown caused by dc protection
50	ERROR	DC Detection not ok, syslog no longer prevented
51	ERROR	Mains Dropout Detection not ok, syslog no longer prevented

3.3.5. RESTful API

There is a RESTful API with JSON data implemented on the device. Every Parameter can be set, and every status can be read over this Interface. All available commands are documented at [REST API DOC](#) on the webpage.

The Base URL is: **`$(HOST_IP)/rest-api/`**.

Table 11. REST API HTTP REQUEST TYPES

TYPE	DESCRIPTION
GET	Get settings or status data
PUT	Set device/channel settings
OPTIONS	Get settings value range and unit
DELETE	Delete resource from device



For **PUT** and **DELETE** HTTP requests, an authentication TOKE in the HTTP header is required:

```
token:f4005bf8507999192162d989d5a60823
```

The command line tool **curl** can be used to execute a rest api request which allows some easy evaluation and debugging mechanism.

See some examples below.

GET DEVICE INFORMATION

COMMAND	info/device
TYPE	GET
CURL-COMMAND	curl \${HOST_IP}/rest-api/info/device
RESPONSE	

```
{
  "model_name": "MA32LP2",
  "channel": 32,
  "options": ["D1", "D2", "IF1", "M1", "IF3"],
  "psu_fan": true,
  "housing_fan": true,
  "sd_card": true,
  "rtc": true,
  "sw_revision": "3.3.0",
  "fpga_revision": "2.9.1",
  "loader_revision": "2.1.4",
  "image_id": 1,
  "serial": "140619000221"
}
```

SET CHANNEL MUTE

COMMAND	settings/channel/{channel_id}/dsp/mute
TYPE	PUT
CURL-COMMAND	curl -X PUT -H 'token: f4005bf8507999192162d989d5a60823' -d '{"value":true}' \${HOST_IP}/rest-api/settings/channel/1/dsp/mute

On Success, the server responded with a **200** response.

On Error, the server returns a error message with a **400** response.

GET CHANNEL VOLUME OPTIONS

COMMAND	settings/channel/{channel_id}/dsp/volume
TYPE	OPTIONS
CURL-COMMAND	curl -X OPTIONS \${HOST_IP}/rest-api/settings/channel/1/dsp/volume
RESPONSE	

```
{"value": [-72.0, 24.0, 0.1, "dB"]}  
{"value": [MIN, MAX, STEP, UNIT]}
```

REMOVE PRESET WITH NAME TEST

COMMAND	preset/storage/{preset_name}
TYPE	DELETE
CURL-COMMAND	curl -X OPTIONS \${HOST_IP}/rest-api/preset/storage/test

On Success, the server responded with a **200** response.

On Error, the server returns a error message with a **400** response. .DELETE error example

```
{  
  "error": "preset not available: test"  
}
```

Chapter 4. PACKAGING

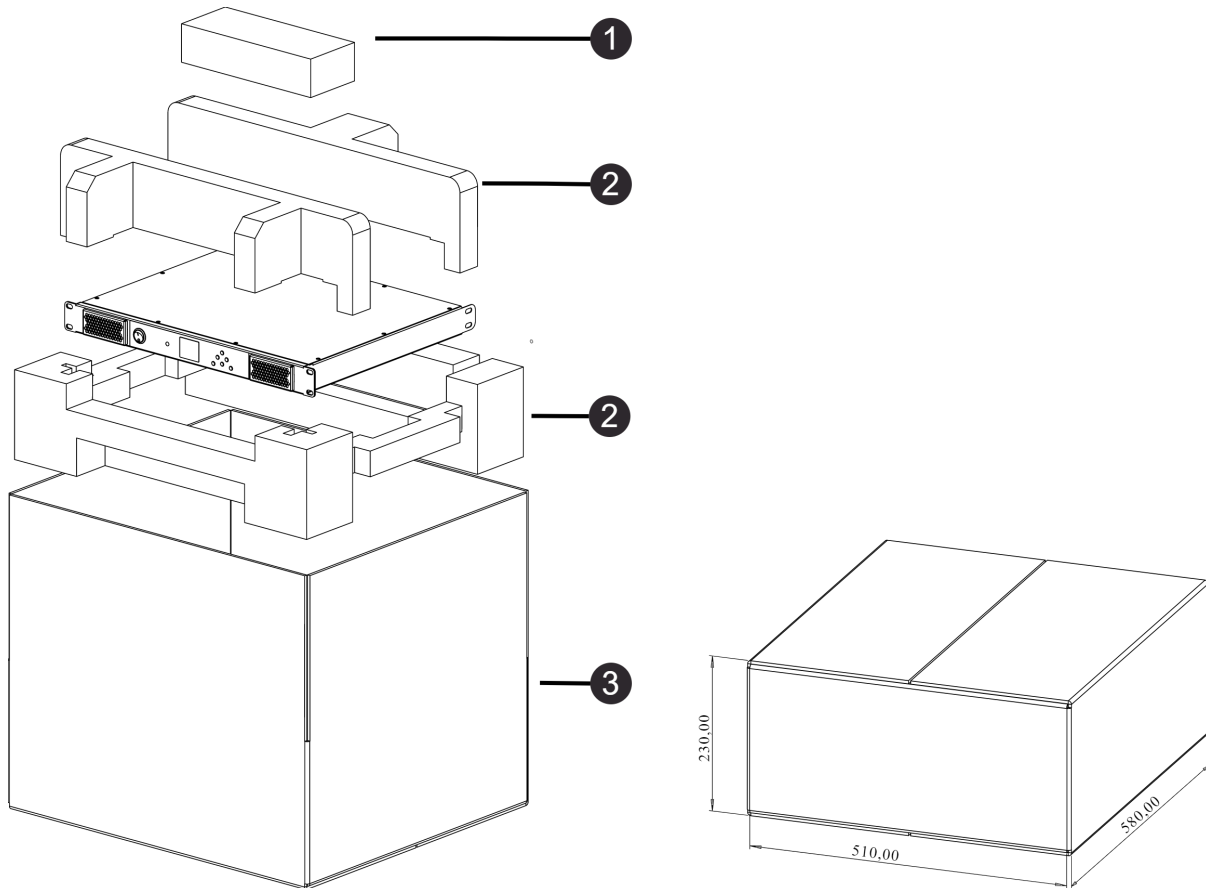

Table 12. DEVICE ELEMENTS

NR	DESCRIPTION
1	accessory box
2	foam insert
3	cardboard with mains cord and speaker connectors

See [SERVICE](#) to order packaging material.

Chapter 5. DISPOSING

Electrical and electronic equipment must be disposed of separately from normal waste at the end of its operational lifetime. Please dispose of this product according to the respective national regulations or contractual agreements. If there are any further questions concerning the disposal of this product, please contact the manufacturer.

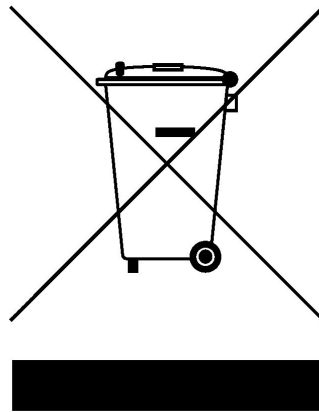

Chapter 6. SERVICE



CAUTION - THESE SERVICING INSTRUCTIONS ARE FOR USE BY QUALIFIED SERVICE PERSONNEL ONLY. TO REDUCE THE RISK OF ELECTRIC SHOCK DO NOT PERFORM ANY SERVICING OTHER THAN THAT CONTAINED IN THE OPERATING INSTRUCTIONS UNLESS YOU ARE QUALIFIED TO DO SO.

ATTENTION - CES CONSIGNES D'ENTRETIEN DOIVENT ETRE UNIQUEMENT EMPLOYES PAR LE PERSONNEL DE SERVICE QUALIFIÉ. POUR RÉDUIRE LE RISQUE DE CHOC ÉLECTRIQUE NE PAS EFFECTUER DES REPARATIONS AUTRES QUE CEUX CONTENUS DANS LES INSTRUCTIONS D'UTILISATION A MOINS QUE VOUS SOYEZ QUALIFIE POUR LE FAIRE

6.1. FUSES

The devices contains internal fuses which are inaccessible to ordinary and instructed persons.

6.2. FIRMWARE UPDATE

It is recommended to update the software to the latest version. To keep the software up to date, see [FIRMWARE UPDATE](#).

6.3. FILTER CLEANING

See ⑤ [MA32LP2 BACK VIEW](#)

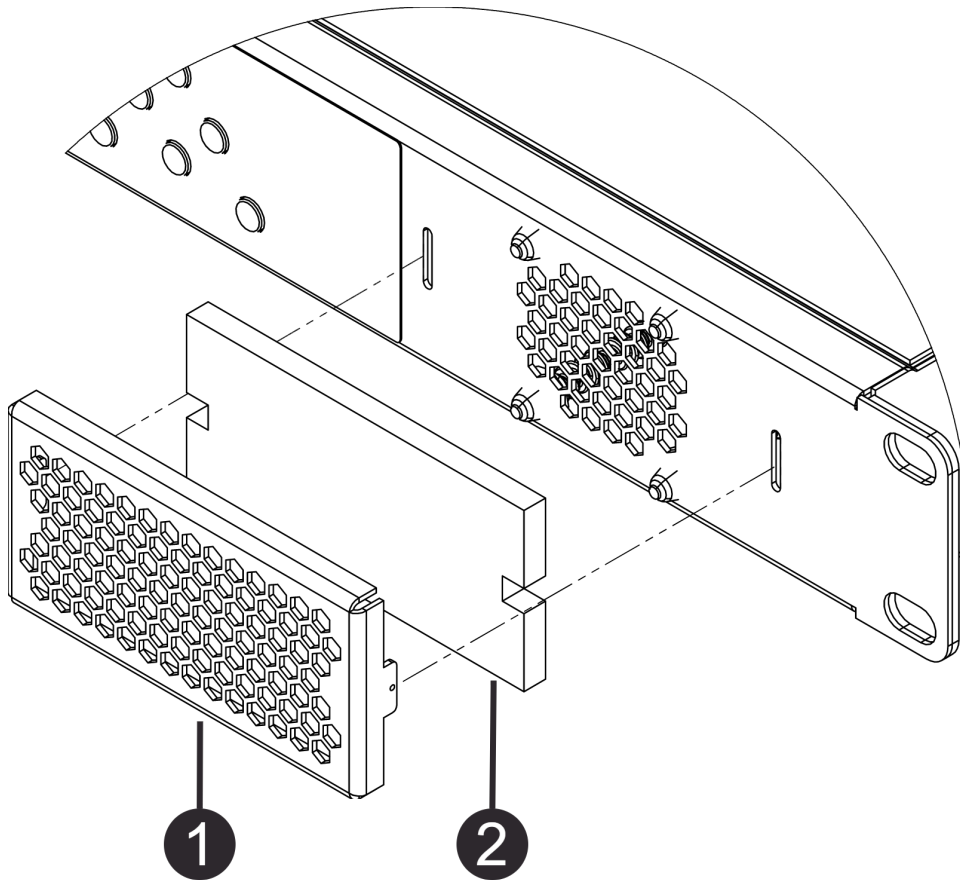

Figure 29. MAXX/LP² filter cleaning / replacement

Please clean the filter when dirty. Depending on the installation environment, a regular check is highly recommended.

Remove the grill ❶ by gently pulling on it, it is attached with magnets, no tools required. Clean the filter ❷ with compressed air and put it back together.

6.4. SPARE PARTS

Table 13. SPARE PARTS

INNOSONIX PART NUMBER	DESCRIPTION	REFERENCE
12578	2-Pol Speaker Connector	CONNECTIONS & CABLE
13386	16-Pol Speaker Connector	CONNECTIONS & CABLE
13319	air filter foam	FILTER CLEANING
13318	fan grill	FILTER CLEANING
13362	power cord C13 Typ E/F 2m (IEC-LOCK C13 to 3-pin Schuko CEE 7/7)	AVAILABLE POWER CORDS

INNOSONIX PART NUMBER	DESCRIPTION	REFERENCE
13363	power cord C13 Typ B 2m (IEC-LOCK C13 to 3-pin USA NEMA5-15)	AVAILABLE POWER CORDS
13364	power cord C13 Typ G 2m (IEC-LOCK C13 to 3-pin GB BS 1363A)	AVAILABLE POWER CORDS

Chapter 7. EU Declaration of Conformity

The company Innosonix GmbH declares under sole responsibility that the products **MA16/LP²**, **MA24/LP²** and **MA32/LP²** complies with the following directives and standards

- EMC Directive **2014/30/EU**
- Low Voltage Directive **2014/35/EU**
- RoHS Directive **2011/65/EU**

7.1. EN 55032:2012

Electromagnetic compatibility of multimedia equipment - **Emission requirements:**

Radiated, Conducted: Class A Limits

7.2. EN 55103-2

EMC Compatibility – Product Family Standard for Audio, Video, Audio-Visual and Entertainment Lighting Control Apparatus for Professional Use, Part 2: **Immunity * EN 61000-4-2:2008 Ed 2.0**

EMC Compatibility – Product Family Standard for Audio, Video, Audio-Visual and Entertainment Lighting Control Apparatus for Professional Use, Part 2: **Immunity * EN 61000-4-3:2010 Ed 3.2**

Radiated, Radio-Frequency, Electromagnetic Immunity (Environment E3, criteria B) * **EN 61000-4-4:2007**

Radiated, Radio-Frequency, EMC Immunity (Environment E3, Criteria B) * **EN 61000-4-5:2006**

Surge Immunity (Criteria B) * **EN 61000-4-6:2006**

Immunity to Conducted Disturbances Induced by Radio-Frequency Fields (Criteria A) * **EN 61000-4-11:2004**

Voltage Dips, Short Interruptions and Voltage Variation

7.3. EN 62368-1:2014/AC:2015

Audio/video, information and communication technology equipment **Part 1: Safety requirements**

7.4. MANUFACTURER

Innosonix GmbH

Hauptstraße 35

D - 96482 Ahorn



Chapter 8. FCC Declaration of Conformity

This equipment has been tested and found to comply with the limits for a Class A digital device, pursuant to Part 15 of the FCC Rules. These limits are designed to provide reasonable protection against harmful interference when the equipment is operated in a commercial environment. This equipment generates, uses, and can radiate radio frequency energy and, if not installed and used in accordance with the instruction manual, may cause harmful interference to radio communications. Operation of this equipment in a residential area is likely to cause harmful interference in which case the user will be required to correct the interference at his own expense.

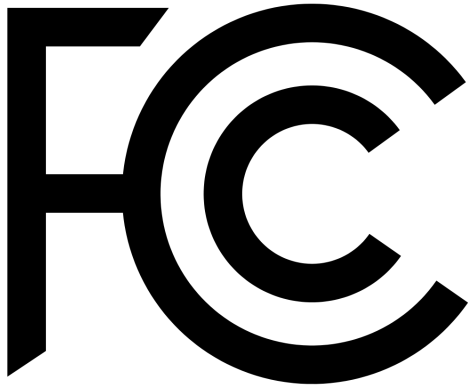



Address : innosonix GmbH
 Hauptstr. 35
 D-96482 Ahorn (Germany)
Phone : +49 (0) 9561 74599-80
Telefax : +49 (0) 9561 74599-89
E-Mail : info@innosonix.de

innosonix GmbH
Executive board: Markus Bätz, Steffen Bätz
USt.-IdNr.: DE 266020313
HRB 5192 Coburg
WEEE-Reg.-Nr. DE 88021242

You can find us on:
www.innosonix.de
www.facebook.com/innosonix.gmbh
www.instagram.com/innosonix.gmbh