



MAXX-SERIES

DIGITAL POWER AMPLIFIERS

MA 16/D²
MA 24/D²
MA 32/D²

INDEX

1. SAFETY INSTRUCTIONS	1
1.1. GENERAL	1
1.2. VENTILATION AND COOLING	3
1.2.1. ACTIVE COOLING	3
1.3. OPERATING CONDITIONS	4
2. TECHNICAL SPECIFICATION	5
2.1. OVERVIEW	5
2.1.1. MA32/D ²	5
2.1.2. MA24/D ²	7
2.1.3. MA16/D ²	8
2.2. DIMENSIONS & WEIGHT	9
2.3. CONNECTIONS & CABLE	10
2.3.1. MAINS SUPPLY	10
AVAILABLE POWER CORDS	12
2.3.2. ETHERNET / DANTE	13
NETWORK MODI	13
DANTE IP SETTINGS	15
CONTROL IP SETTINGS	15
HOSTNAME	15
NETWORK SERVICES	15
2.3.3. MADI (AES10) / AES3	16
MADI Optical	16
MADI Coaxial / AES3	16
2.3.4. AMP OUTPUT	17
2.3.5. POWER DISTRIBUTION	18
3. SOFTWARE	19
3.1. IDFM (FIRMWARE UPDATE AND IP CONTROL)	19
3.1.1. DISCOVERY	20
3.1.2. IP SETTINGS	21
3.1.3. FIRMWARE STORAGE	22
3.1.4. FIRMWARE UPDATE	23
3.2. DSP (internal)	24
3.3. USER INTERFACES	25
3.3.1. DISPLAY / BUTTONS	25
DISPLAY MENU	25
OVERVIEW	26
DISPLAY DEVICE LOCK	26
3.3.2. POWER LED	27
3.3.3. WEBSITE	28



HEADER	28
PAGES	29
SAVE INTERNAL STORAGE	29
PSU LIMIT	29
AMP STATUS	30
FOOTER	31
OVERVIEW	32
INTERFACES	52
DEVICE	54
MUTEGROUPS	56
PRESETS	57
LOGGING	58
METERING	59
3.3.4. ERROR CODES	60
3.3.5. RESTful API	62
GET DEVICE INFOMRATIONS	63
SET CHANNEL MUTE	63
GET CHANNEL VOLUME OPTIONS	64
REMOVE PRESET WITH NAME TEST	64
4. DISPOSING	65
5. SERVICE	66
5.1. FUSES	66
5.2. FIRMWARE UPDATE	66
5.3. FILTER CLEANING	66
5.4. SPARE PARTS	67
6. EU Declaration of Conformity	68
6.1. EN 55032:2012	68
6.2. EN 55103-2	68
6.3. EN 62368-1:2014/AC:2015	69
6.4. MANUFACTURER	69
7. FCC Declaration of Conformity	70

Chapter 1. SAFETY INSTRUCTIONS

1.1. GENERAL

Before using the product, please read this manual and follow all Safety Instructions. They are used to protect you, help to avoid equipment defects and damages resulting from improper use. Keep this manual in a safe place.



CAUTION: THE POWER SUPPLY CORD IS USED AS THE MAIN DISCONNECT DEVICE, ENSURE THAT THE SOCKET-OUTLET IS LOCATED/INSTALLED NEAR THE EQUIPMENT AND IS EASILY ACCESSIBLE

ATTENTION: LE CORDON D'ALIMENTATION EST UTILISÉ COMME INTERRUPTEUR PRINCIPAL. LA PRISE DE COURANT DOIT ÊTRE SITUÉE OU INSTALLÉE À PROXIMITÉ DE L'ÉQUIPEMENT ET ÊTRE FACILE D'ACCÈS



CAUTION - DANGER OF EXPLOSION IF BATTERY IS INCORRECTLY REPLACED. REPLACE ONLY WITH THE SAME OR EQUIVALENT TYPE.

ATTENTION - DANGER D'EXPLOSION LORSQUE LA BATTERIE N'EST PAS REMPLACÉE CORRECTEMENT. REMPLACER UNIQUEMENT AVEC DES BATTERIES IDENTIQUES OU D'UN TYPE ÉQUIVALENT



CAUTION - THESE SERVICING INSTRUCTIONS ARE FOR USE BY QUALIFIED SERVICE PERSONNEL ONLY. TO REDUCE THE RISK OF ELECTRIC SHOCK DO NOT PERFORM ANY SERVICING OTHER THAN THAT CONTAINED IN THE OPERATING INSTRUCTIONS UNLESS YOU ARE QUALIFIED TO DO SO.

ATTENTION - CES CONSIGNES D'ENTRETIEN DOIVENT ÊTRE UNIQUEMENT EMPLOYÉES PAR LE PERSONNEL DE SERVICE QUALIFIÉ. POUR RÉDUIRE LE RISQUE DE CHOC ÉLECTRIQUE NE PAS EFFECTUER DES REPARATIONS AUTRES QUE CEUX CONTENUS DANS LES INSTRUCTIONS D'UTILISATION A MOINS QUE VOUS SOYEZ QUALIFIÉ POUR LE FAIRE



The amplifier is a device of protection class 1. Make sure that the protective conductor (earth) is connected properly. A missing earth can lead to dangerous voltages at the enclosure!



Keep the device away from dust, moisture, water and other liquids! In such case, the further usage is prohibited!



The amplifier has a relatively high output power and possibly can be a hazard for people and speakers. Pay particular attention to any defective set volume.



Do not touch the housing of the device, during operation. The surfaces can be hot. After switching off the device, wait 30 minutes till touching the device.



In the following cases it is necessary to return the amplifier for examination to the manufacturer. Contact details can be found on our website: www.innosonix.de

- The unit has been dropped, mechanically damaged or treated improperly.
- The power cord or plug has been damaged.
- Objects have fallen into the unit.
- Liquid has been spilled into the unit.
- The unit is not operating normally.
- The device displays errors.

1.2. VENTILATION AND COOLING



Built-in and 19-inch racks must be ventilated adequately.

1.2.1. ACTIVE COOLING

The active cooling system inside the device creates front to back ventilation.

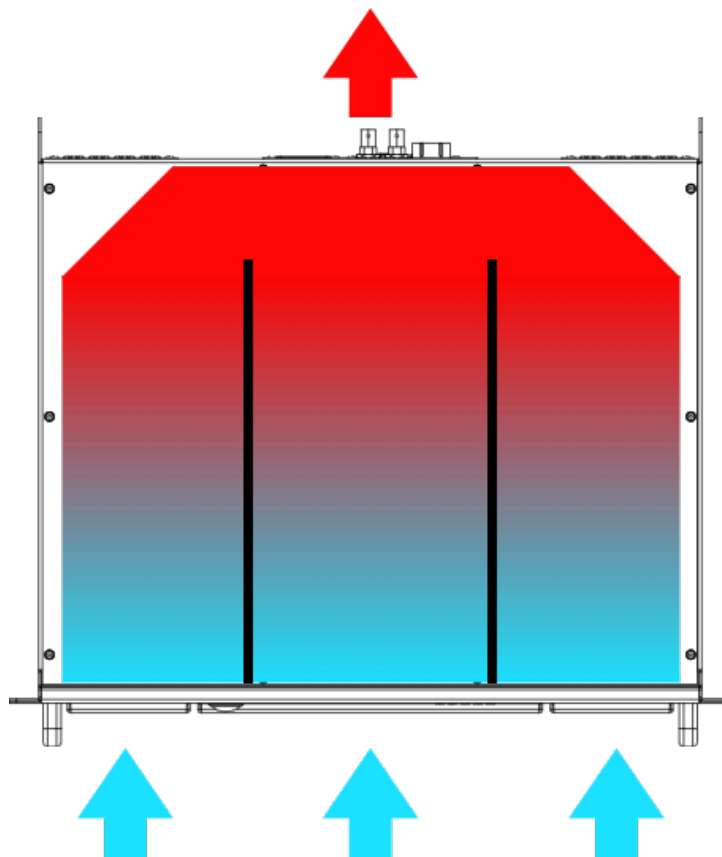

Figure 1. MAXX/D² Ventilation

1.3. OPERATING CONDITIONS

Enviromental operating temperature	0 - 40°C			
Thermal dissipation	Fan, variable speed, temperature controlled front to rear airflow			
	32 CH			
	@230V		@110V	
amps power off	31 kcal/h	123 BTU/h	31 kcal/h	123 BTU/h
idle	84 kcal/h	333 BTU/h	88 kcal/h	349 BTU/h
1/8 power @ 4 Ohm	269 kcal/h	1066 BTU/h	270 kcal/h	1071 BTU/h
	24 CH			
	@230V		@110V	
amps power off	31 kcal/h	123 BTU/h	31 kcal/h	123 BTU/h
idle	71 kcal/h	282 BTU/h	72 kcal/h	286 BTU/h
1/8 power @ 4 Ohm	210 kcal/h	833 BTU/h	212 kcal/h	840 BTU/h
	16 CH			
	@230V		@110V	
amps power off	31 kcal/h	123 BTU/h	31 kcal/h	123 BTU/h
idle	58 kcal/h	230 BTU/h	58 kcal/h	230 BTU/h
1/8 power @ 4 Ohm	150 kcal/h	595 BTU/h	152 kcal/h	603 BTU/h

Chapter 2. TECHNICAL SPECIFICATION

2.1. OVERVIEW

2.1.1. MA32/D²

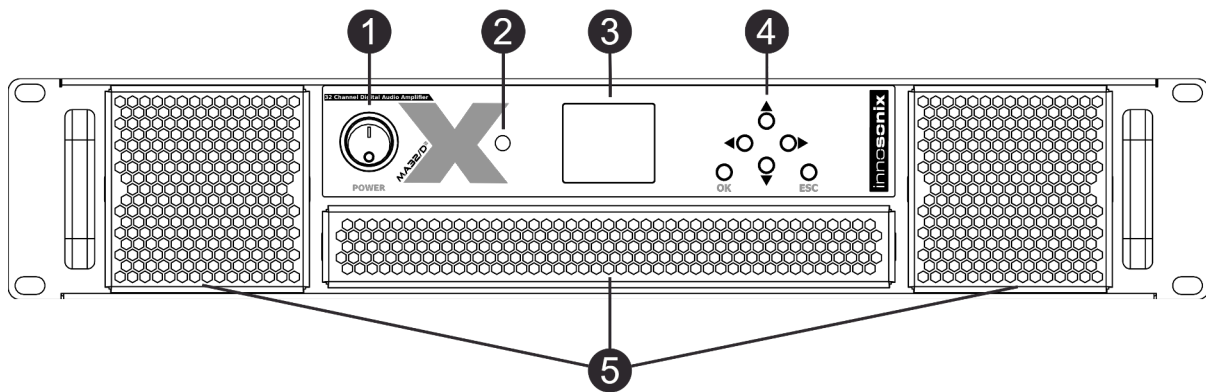

Figure 2. MA32/D² front view

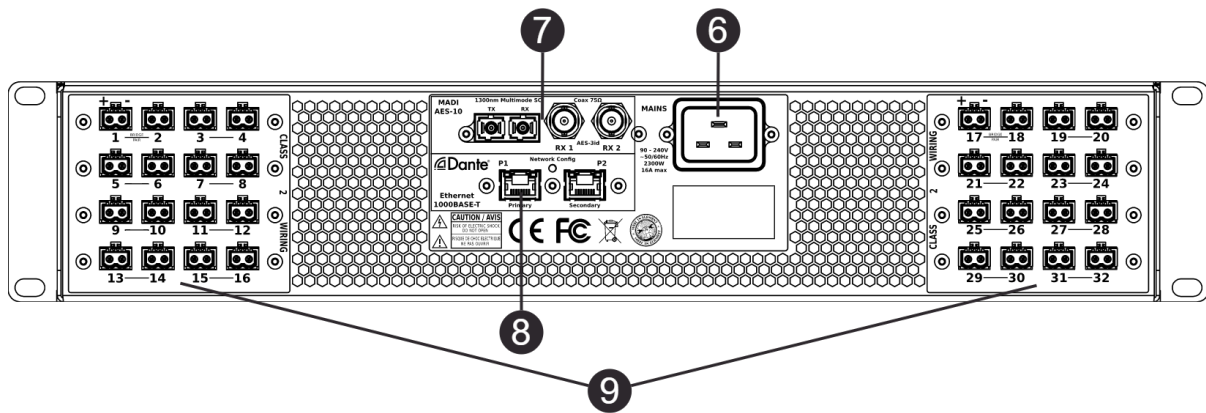

Figure 3. MA32/D² back view

Table 1. DEVICE ELEMENTS

NR	DESCRIPTION	REFERENCE
1	POWER SWITCH	MAINS SUPPLY
2	POWER LED	POWER LED
3	DISPLAY	DISPLAY / BUTTONS
4	BUTTONS	DISPLAY / BUTTONS
5	VENTILATION GRILLS	SERVICE

NR	DESCRIPTION	REFERENCE
⑥	MAINS SUPPLY	MAINS SUPPLY
⑦	MADI	MADI (AES10) / AES3
⑧	ETHERNET/DANTE	ETHERNET / DANTE
⑨	AMP OUTPUTS	AMP OUTPUT

2.1.2. MA24/D²

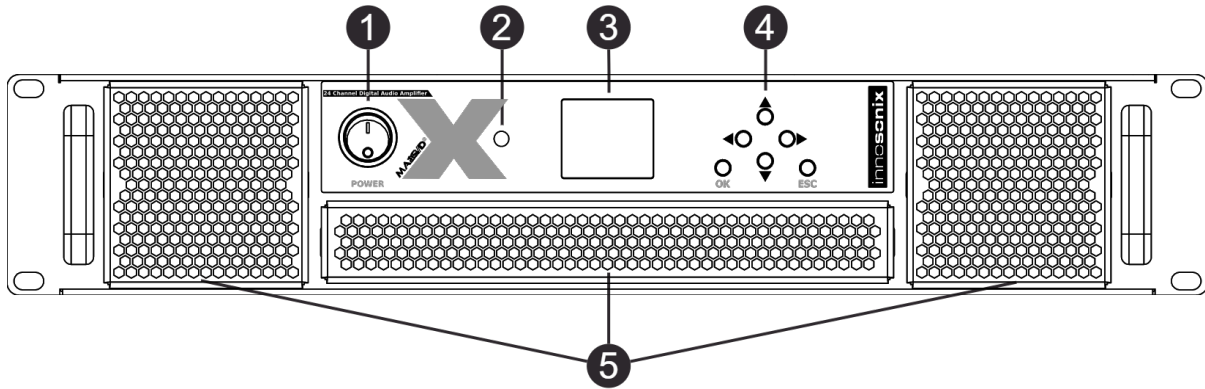

Figure 4. MA24/D² front view

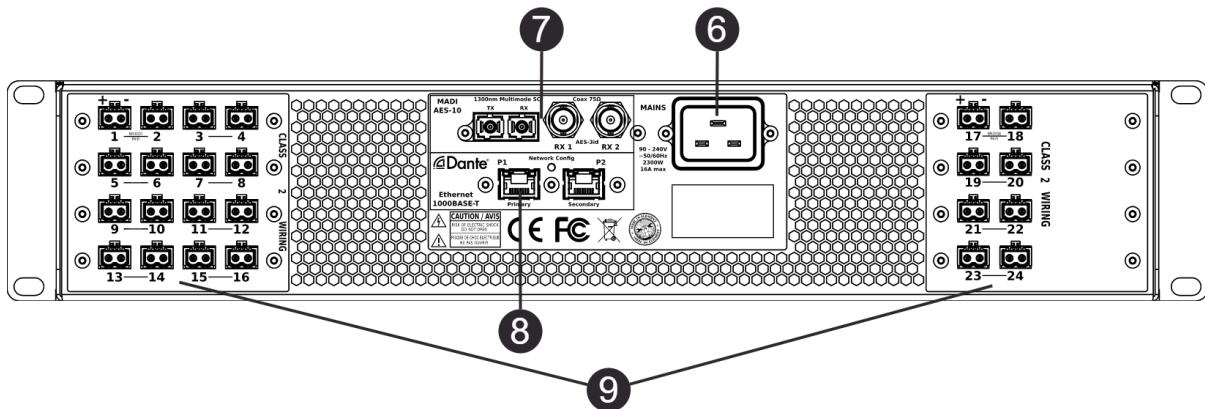

Figure 5. MA24/D² back view

Table 2. DEVICE ELEMENTS

NR	DESCRIPTION	REFERENCE
1	POWER SWITCH	MAINS SUPPLY
2	POWER LED	POWER LED
3	DISPLAY	DISPLAY / BUTTONS
4	BUTTONS	DISPLAY / BUTTONS
5	VENTILATION GRILLS	SERVICE
6	AMP OUTPUTS	AMP OUTPUT
7	MADI	MADI (AES10) / AES3
8	ETHERNET/DANTE	ETHERNET / DANTE
9	MAINS SUPPLY	MAINS SUPPLY

2.1.3. MA16/D²

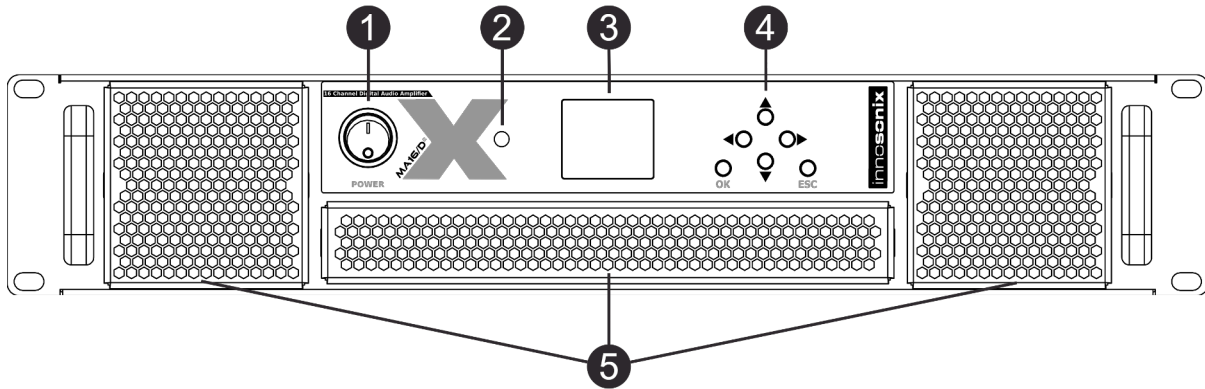

Figure 6. MA16/D² front view

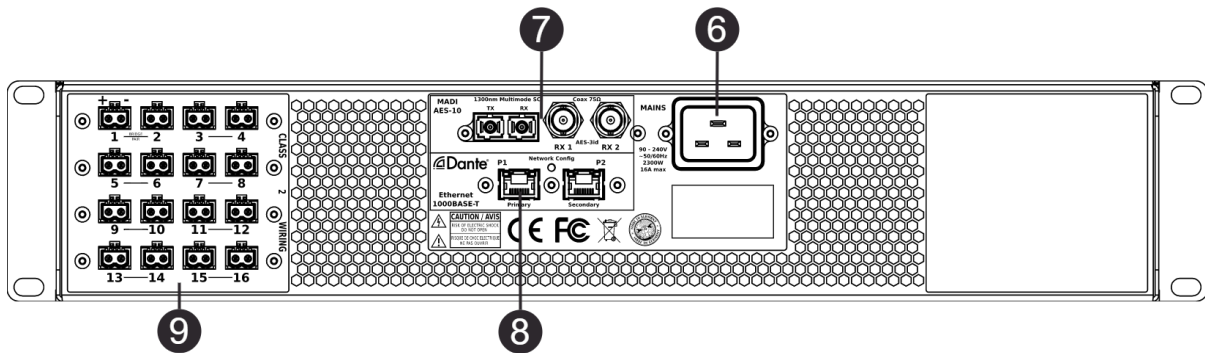

Figure 7. MA16/D² back view

Table 3. DEVICE ELEMENTS

NR	DESCRIPTION	REFERENCE
1	POWER SWITCH	MAINS SUPPLY
2	POWER LED	POWER LED
3	DISPLAY	DISPLAY / BUTTONS
4	BUTTONS	DISPLAY / BUTTONS
5	VENTILATION GRILLS	SERVICE
6	AMP OUTPUTS	AMP OUTPUT
7	MADI	MADI (AES10) / AES3
8	ETHERNET/DANTE	ETHERNET / DANTE
9	MAINS SUPPLY	MAINS SUPPLY

2.2. DIMENSIONS & WEIGHT

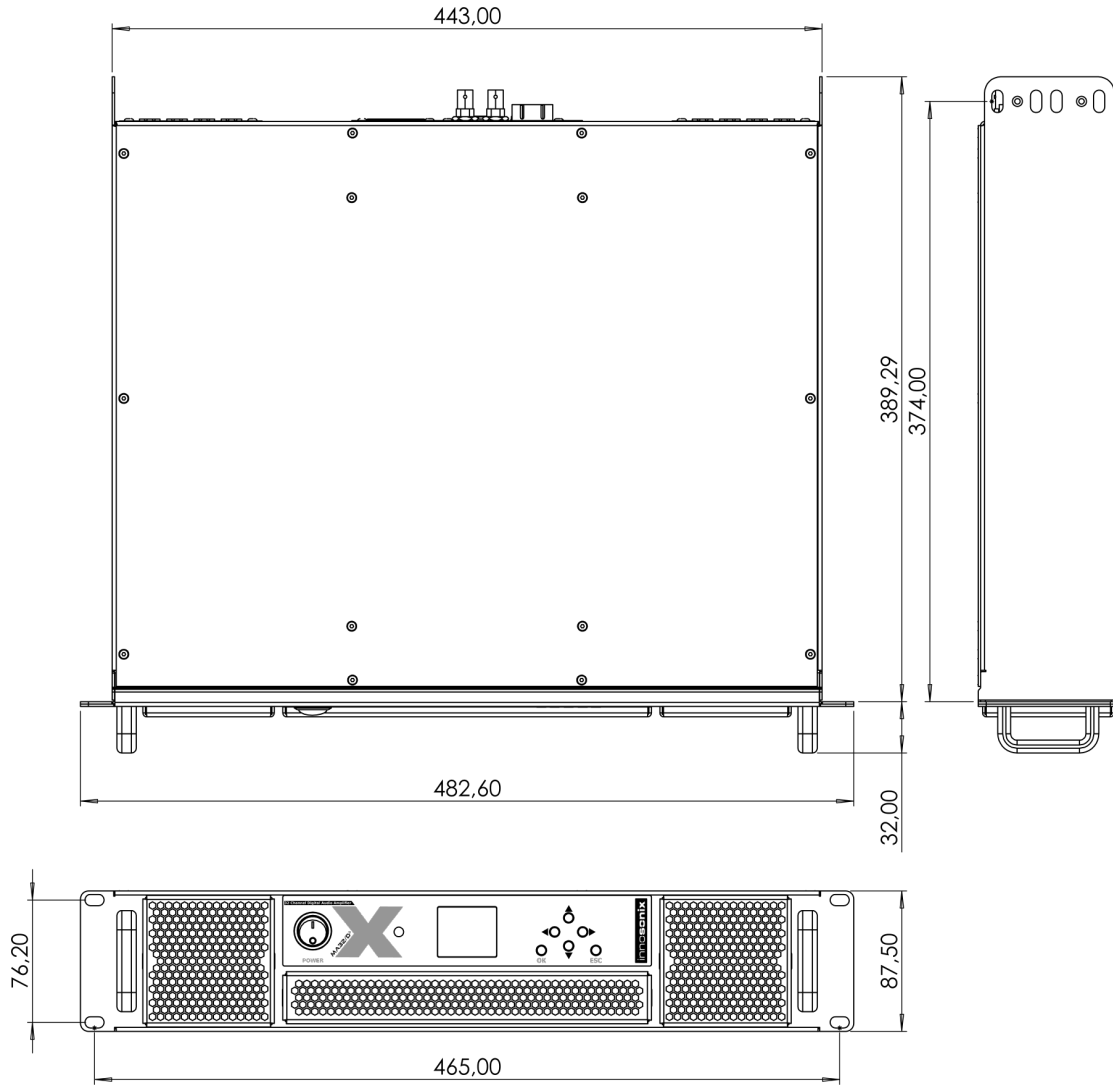

Figure 8. MAXX/D² dimensions

Dimensions	W 482.60mm (19") H 87.50mm (2 RU), D 389.29mm		
	32CH	24CH	16CH
Weight	15.0 kg	14.3 kg	13.0 kg

2.3. CONNECTIONS & CABLE

Control input connectors	RJ45 (100Mbit/s Ethernet)
Audio signal input connectors	RJ45 (DANTE), BNC 75R (MADI Coax, AES3id), SC Optic (MADI Fibre)
Speaker connector	Wuerth Elektronik 691352710002 Phoenix Contact MSTB 2,5/ 2-ST - 1754449
AC mains	C19

A chapter that describes available hardware interconnections with recommendations to cable and settings.

2.3.1. MAINS SUPPLY

See ❶ and ❸ [MA32D2 BACK VIEW](#)

Power supply	Universal, regulated switch mode with PFC (Power Factor Correction)	
Operating Voltage	90 - 264VAC 50/60Hz	
AC Current typ.	@230V	@110V
	10A	16A
Inrush Current	50A max.	
Suggested circuit breaker	B16	
Earth Leakage Current	<2mA / 240V	

32 CH Version		
Power Factor	@230V	@110V
amps power off	0.46	0.85
idle	0.64	0.95
1/8 power @ 4 Ohm	0.96	0.98
Consumption / current draw	@230V	@110V
amps power off	36W	36W
idle	98W	102W
1/8 power @ 4 Ohm	1514W	1532W

24 CH Version		
---------------	--	--

Power Factor	@230V	@110V
amps power off	0.44	0.83
idle	0.58	0.93
1/8 power @ 4 Ohm	0.94	0.99
Consumption / current draw	@230V	@110V
amps power off	36W	36W
idle	83W	84W
1/8 power @ 4 Ohm	1145W	1150W

16 CH Version		
Power Factor	@230V	@110V
amps power off	0.44	0.83
idle	0.58	0.93
1/8 power @ 4 Ohm	0.94	0.99
Consumption / current draw	@230V	@110V
amps power off	36W	36W
idle	67W	68W
1/8 power @ 4 Ohm	775W	778W



The device contains an internal fuse see: [FUSES](#)

The Amplifier comes with a power cord according to the planned place of use. See [SERVICE](#) to order a new or different power cord.

AVAILABLE POWER CORDS

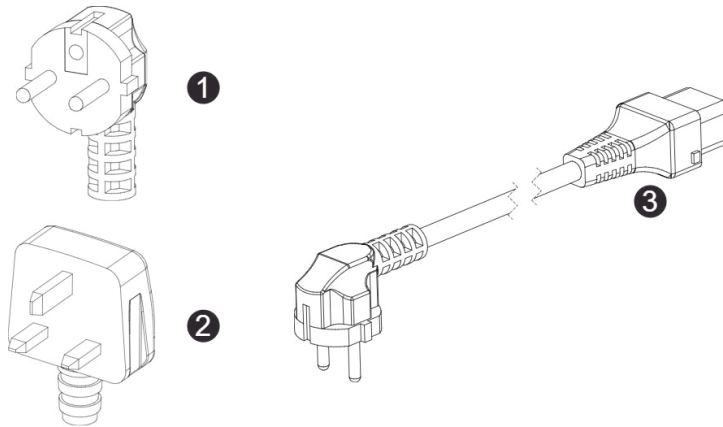

NR	DESCRIPTION
①	3-pin Schuko CEE 7/7
②	3-pin GB BS 1363A
③	IEC-LOCK C19

To release the cable from the amplifier, the red Button has to be pushed to the back.

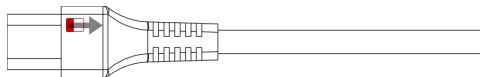

2.3.2. ETHERNET / DANTE

See 7 MA32D2 BACK VIEW

There are two different network devices inside the amplifier, the Control Module and the Dante Module. There are three different network modes that determine which device can be reached at which network port.



Do not connect both Port to the same Switch if no different VLANs are configured.

NETWORK MODI

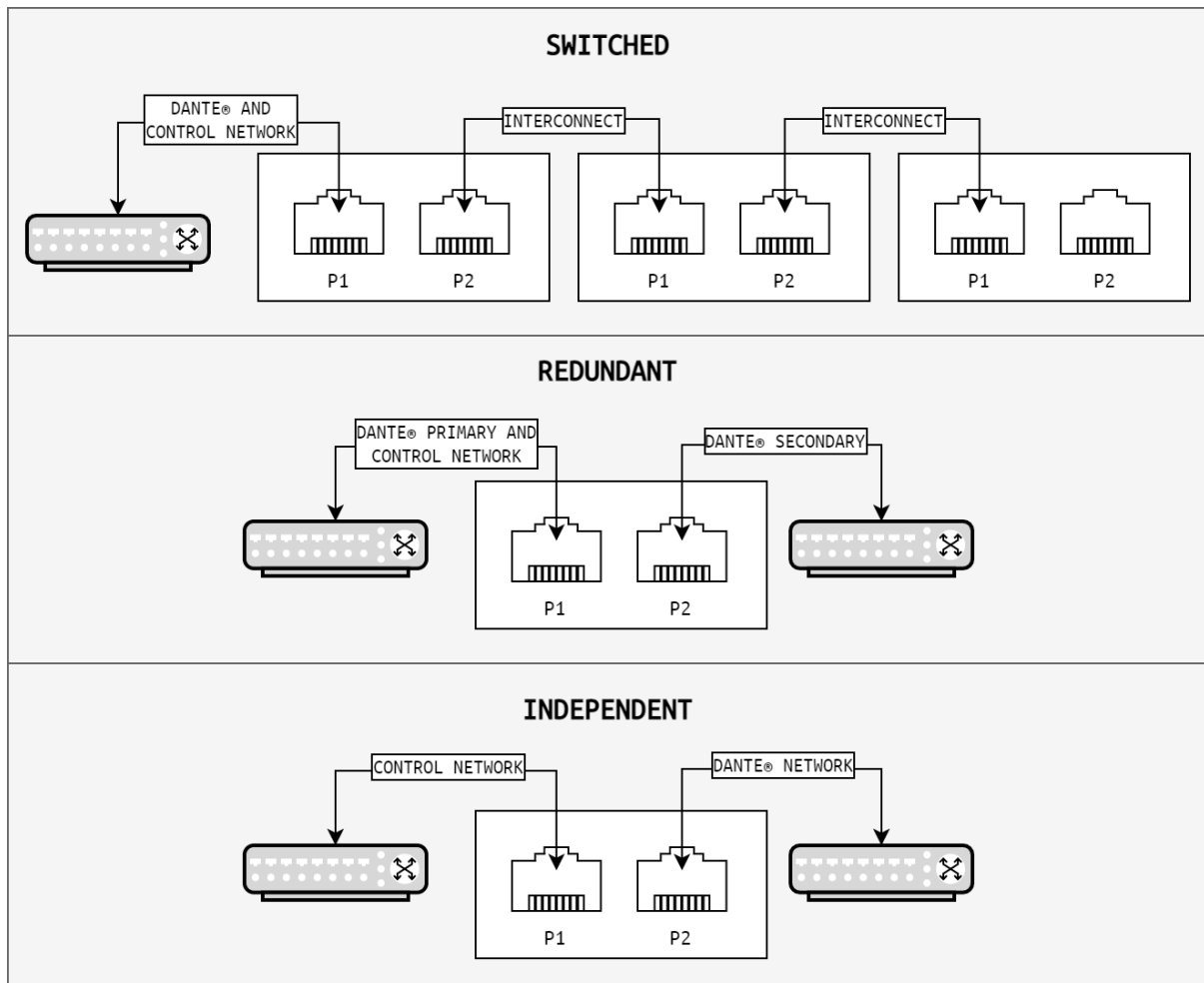

Figure 9. NETWORK MODI

To **change** the network modes, the **Dante Controller** Software is required. ([DOWNLOAD HERE](#))

Open the **Dante Controller** and go to Device View:

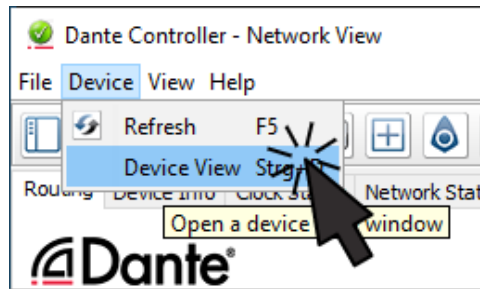

Figure 10. Dante Controller

The Device View Popup appears:

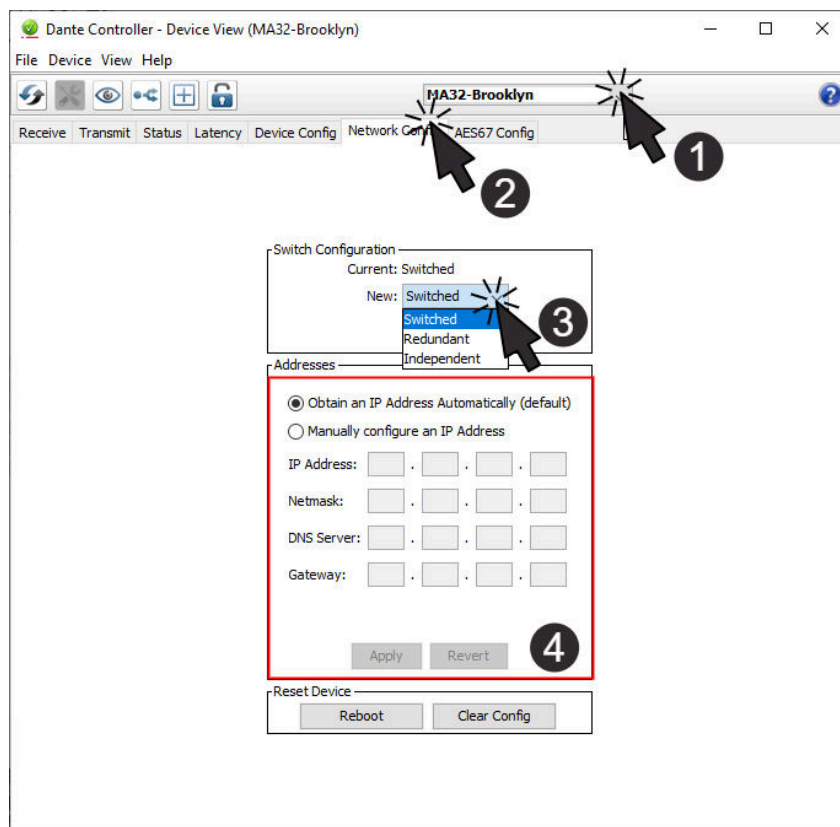

Figure 11. Dante Device View

Select the device in the Dropdown **1** and change to tab **Network Config 2**. The currently selected network mode appears in the **Switch Configuration** box. By selecting the new Mode **3**, a Popup opens that asked, whether you're really sure to do that. After clicking **YES**, the Brooklyn Module inside the Amplifier restart, so it can take a few seconds till the Dante Device is back online.

DANTE IP SETTINGS

To control and change IP Settings of DANTE, please use ④ in [Dante Device View](#).

CONTROL IP SETTINGS

There are several ways to change the **IP** of an Amplifier. See [DISPLAY MENU](#) to change on Display Menu, [DEVICE](#) to change on Website or use the external software **IDFM** (see [IP SETTINGS](#)).

There are three different IP Types available:

Table 4. IP TYPES

TYPE	DESCRIPTION
static	set IP, SUBNET and GATEWAY manually
dhcp	system tries to get a DHCP release, there is also an auto ip fallback, if no lease available
auto-ip	force zeroconf IP, device will get an address with a 169.254/16 prefix (that is, 169.254.xxx.xxx)

HOSTNAME

With mDNS the device is also available with its hostname. With hostname **AMP1** the local name is **AMP1.local**. The Name can be used to call every network service.

There are several ways to change the **Hostname** of an Amplifier. See [DEVICE](#) to change on Website or use the external software **IDFM**.

NETWORK SERVICES

- Full remote control via the website hosted on the device (see [WEBSITE](#))
- REST-API, JSON based web service for integration in media control systems (see [RESTful API](#))
- mDNS name resolution and servicediscovery ([INFO HERE](#))
- syslog integration to send notifications to external syslog server ([INFO HERE](#))

2.3.3. MADI (AES10) / AES3

See [8 MA32D2 BACK VIEW](#)

MADI (**M**ultichannel **A**udio **D**igital **I**nterface) or **AES10** is a standard that defines electrical characteristics and the data format of an interface that carries multiple channels of digital audio. There are two Coaxial Inputs available, which also can be used as AES3 Inputs, one optical input and an optical output. On every Input the device supports **44.1kHz / 48kHz** with **56 / 64** channels and **88.2 kHz / 96kHz** with **28 / 32** channels.

MADI Optical

To use the Optical MADI interface, a **1300nm multimode** cable with **SC** connectors is required.

MADI Coaxial / AES3

The two BNC (75 Ohm) jacks are multifunctional inputs and can be used as AES10 MADI or AES3 interface.

To use the BNC input for AES3, a 110 to 75 Ohm impedance transformer like [\(NADITBNC-F\)](#) or [\(NADITBNC-FX\)](#) is required.

Every AES3 input has an asynchronous samplerate converter enabled which can handle samplerates from 32kHz - 192kHz.

2.3.4. AMP OUTPUT

See ⑥ [MA32D2 BACK VIEW](#) To connect speakers, use 2-Pol Terminal Blocks [SERVICE](#).

Output Power (EIAJ Test Standard 1kHz 1% THD)	4Ω	8Ω	8Ω Bridge-Mode	
	280W	140W	500W	
Max output Voltage	52 V _{peak}		104 V _{peak}	
Max output Current	20 A _{peak}		20 A _{peak}	
DC Offset	<25mV			
Frequency response	10Hz-20kHz / 4-8Ω: +0.5 -0.5dB			
S/N typ	105dBA			
Analog Gain	Software Adjustable, 0dBFS on any Input Interface ⇒ 20V _p - 60V _p (default: 60V _p)			
THD+N @ 4Ω	1W	10W	280W	300W
	< 0.05%	< 0.05%	1%	2%
SMPTE IMD	< 0.1% @ 1/8 Power 4Ω			
CCIF IMD	< 0.1% @ 1/8 Power 4Ω			
Output impedance	typ 10 mΩ			
Crosstalk	channel enabled		channel disabled	
	typ < 75dB	typ 90dB (distant channels)	typ < 100dB	
Latency @48kHz	1.1ms			
Protection	Overtemperature, DC and Overcurrent			

2.3.5. POWER DISTRIBUTION



- The power supply can deliver 2000W continuous power. To ensure a stable operation in overload situations, the MAXX/D² involves an overall power limiter. With an attack time of 100ms and a release of 3s the limiter softly reduces the gain of all channels simultaneously not to exceed the maximum available power. At 110V lines, a derating of 20% must be considered.
- The pulse power of 32 * 280W is buffered through capacitors and is certainly available as a burst only.
- An amplifier efficiency of 90% can be expected.
- All amplifiers are sourced by one powersupply.
- Assuming an evenly distribution of load between all channels, the MAXX/D² is able to source 55W continuous sine power per channel. At 110V line it is after all 44W.

Chapter 3. SOFTWARE

3.1. IDFM (FIRMWARE UPDATE AND IP CONTROL)

The IDFM (Innosonix **D**iscovery and **F**irmware **M**anager) is available for Windows 10, MAC OSX and Linux. Have a look at our [Download Area](#)

It is designed to discover MAXX Devices across subnets and across network modes (See [ETHERNET / DANTE](#)). It also handles Firmware updates of MAXX Devices.

3.1.1. DISCOVERY

The Discovery process starts after opening the IDFM Tool. All available Devices will appear in the list view.



Be sure the firewall allows TCP and UDP connections.

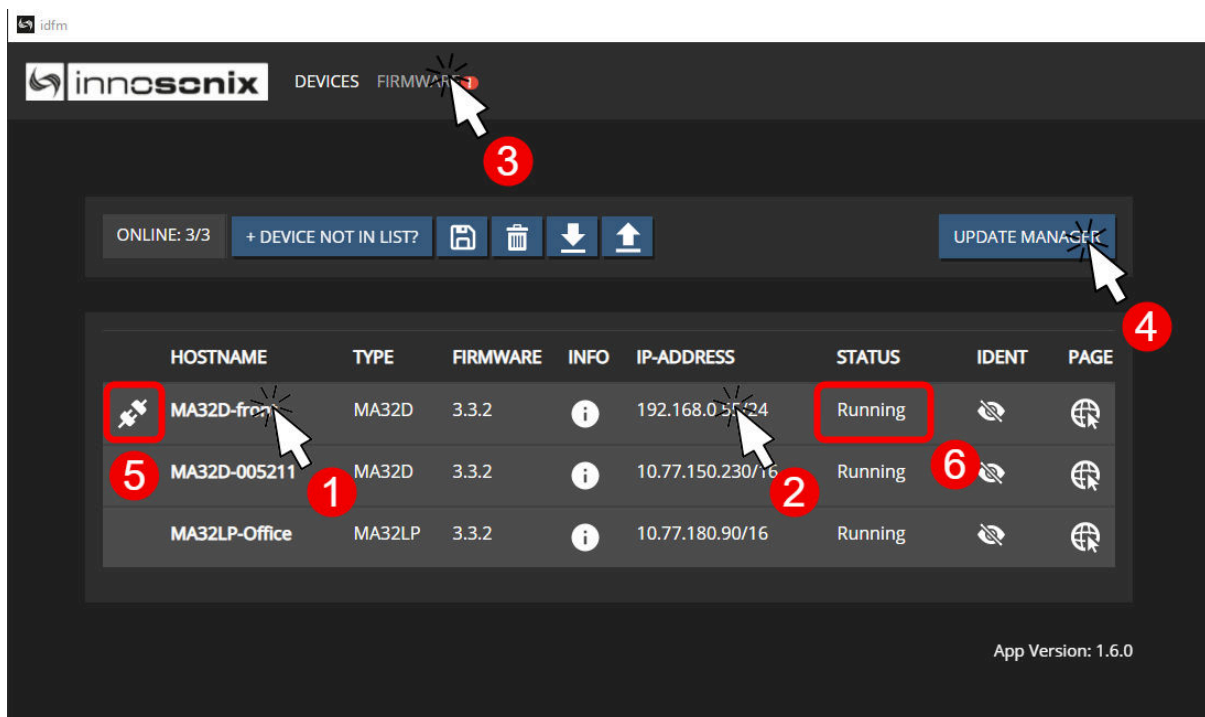

Figure 12. IDFM Discovery

NR	DESCRIPTION	REFERENCE
1	Change Hostname	
2	Change IP Settings	IP SETTINGS
3	Download / Import Firmware Files	see FIRMWARE
4	Update Devices	UPDATE
5	Device not in same Subnet ⇒ cannot be updated	
6	Actual Device Status (Update Status)	

3.1.2. IP SETTINGS

After clicking on the IP Address in [IDFM Discovery](#) view, following popup appears to change IP Settings.

IP Settings are described here [Control IP](#)

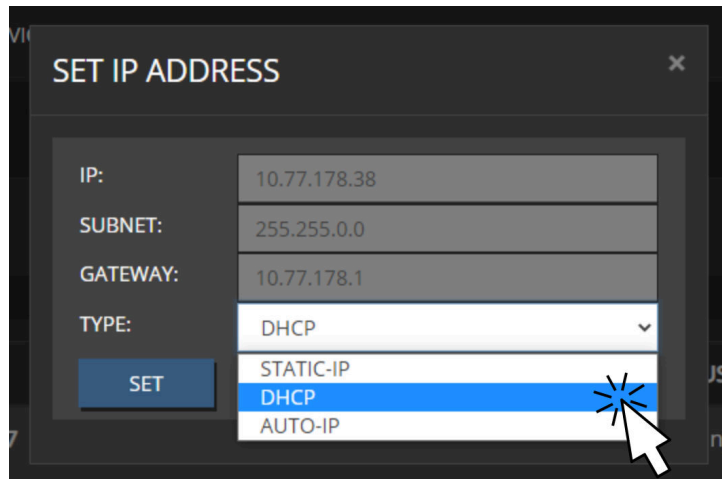

Figure 13. IDFM IP Settings

3.1.3. FIRMWARE STORAGE

To update the firmware of a MAXX Device, the correct Firmware must be available in the firmware storage.

If there is no Internet connection available, the newest firmware cannot be loaded from our server **2**. With **1** a firmware image files can be uploaded manually.

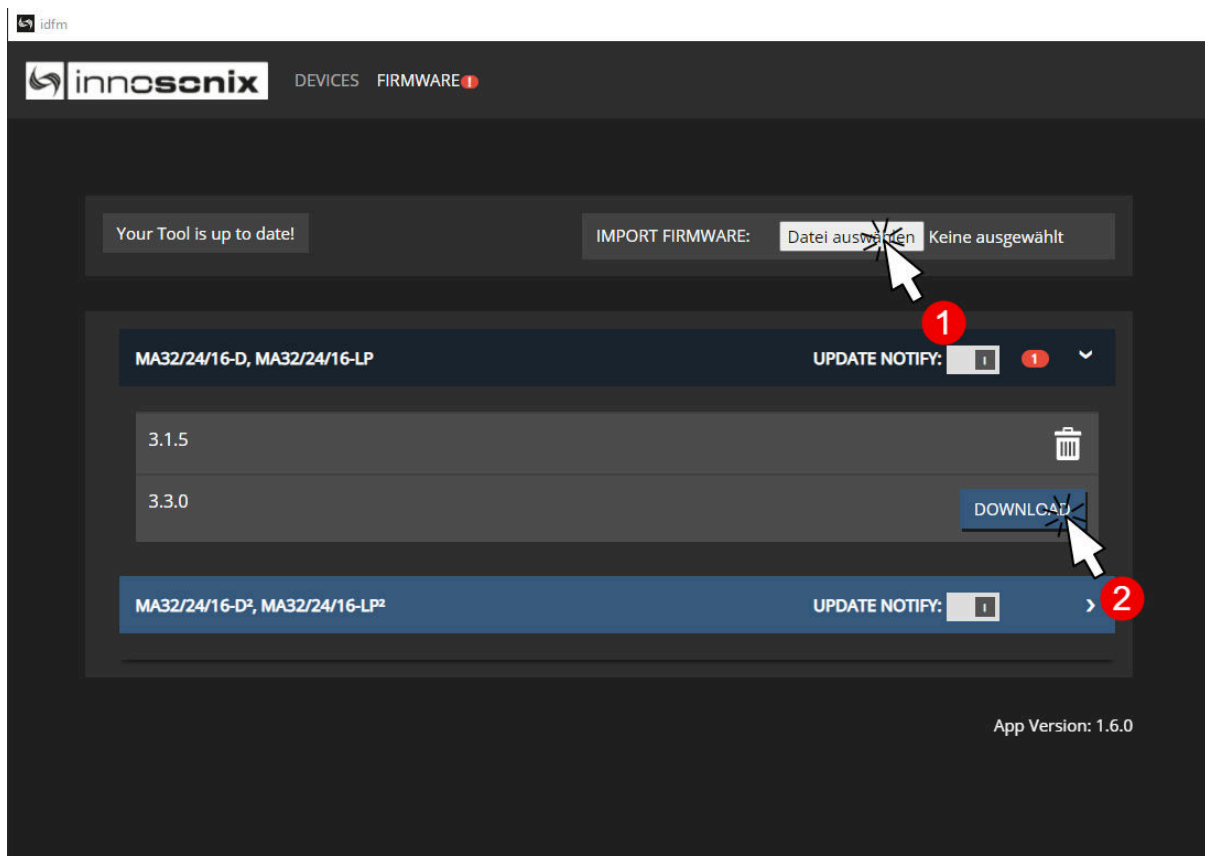

Figure 14. IDFM Firmware storage

3.1.4. FIRMWARE UPDATE

After loading a correct firmware file to the [FIRMWARE STORAGE](#), the firmware can be selected in the firmware update popup. If no Firmware is selected, the device will be ignored. After confirming the update, the update status can be seen at [6](#) on [IDFM Discovery](#).



After firmware Update completed, the Device restarts automatically.

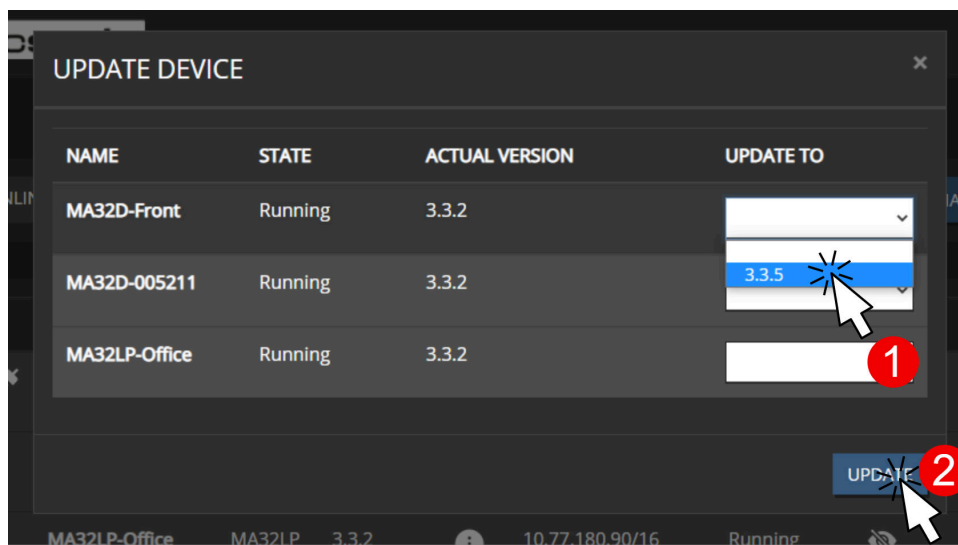

Figure 15. IDFM Firmware update

3.2. DSP (internal)

A DSP is a digital signal processing chain inside the FPGA that calculates the volume control, filtering and limiting parameters on the selected Input Source. There are as many DSP channels as amplifier outputs on the MAXX device. DSPs are "hardwired" to the corresponding amplifier, e.g. DSP channel 1 supplies an amplifier that is wired to CH1 Jack on the rear panel.

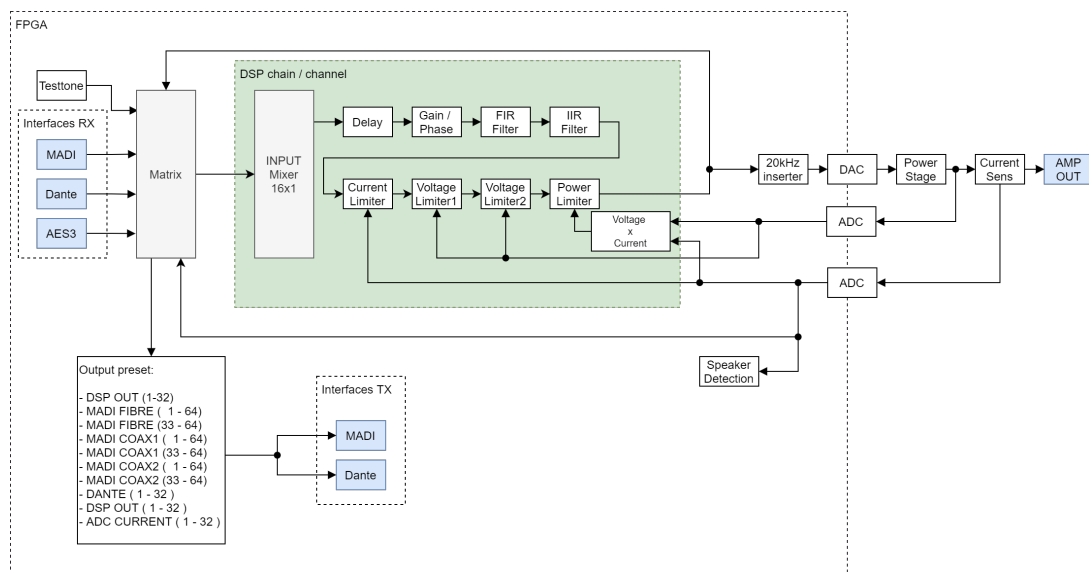

Figure 16. DSP Block Image

DSP Features

Architecture	FPGA based 32-bit fixed point
Inputs	16 x input matrix
	sine, white- pink- brown-noise
	Mute, Volume, Phase
Filter per channel	32 x EQ / Highpass / Lowpass
Filter types	bell, notch, highshelf, lowshelf
High- Lowpass types	6 - 48dB/Oct, Bessel, Butterworth, Linkwitz/Riley, Variable Q
FIR Filter	2048 Tabs, ASCII file import
Delay	48000 Samples / 330m / 1000ms per channel
CurrentLimiter	Threshold [Ap]
VoltageLimiter	2 x Threshold [Vp], Attack, Release
Powerlimiter	Threshold [W], Attack, Release
Speakerdetection	20kHz Pilot Tone generating with Volume, Threshold, Debounce

3.3. USER INTERFACES

3.3.1. DISPLAY / BUTTONS

See ③ and ④ on [FRONT VIEW](#)

DISPLAY MENU



Figure 17. MENU STRUCTURE

Table 5. MENU PAGES

NR	DESCRIPTION
①	Overview Page with Hostname, IP and Channel Status (see. OVERVIEW)
②	Status Page with Temperatures and PSU Load and Fan Speeds
③	Info Page with Model, Serial, Software Version and Software Options
④	Network Settings Page to change IP type and address

OVERVIEW

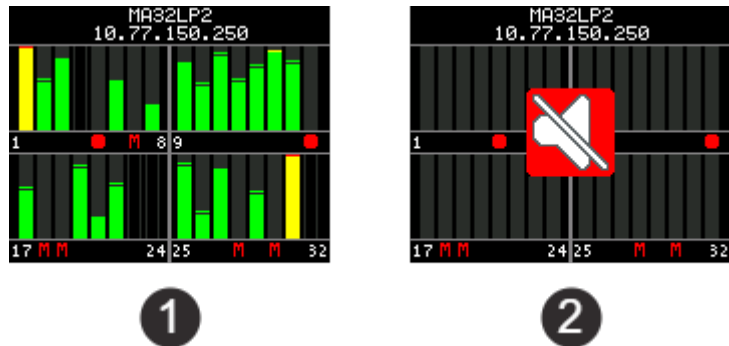

Figure 18. OVERVIEW EXAMPLES

The Overview Page appears at startup, and after a 30 seconds timeout, if another page is selected and no user input occurs. Every channel has its own Levelmeter from **-60dBFS** to **0dBFS** with **PEAK** as a bar and **HOLD** as a horizontal line. The Overview ① shows **CHANNEL MUTE** State (CH 7, 18, 19, 18, 30), if the amplifier channel is **disabled** (CH 4, 23, 24, 32) or the amp channel has an **error** (CH 5, 16).

If **Master Mute** is enabled, the crossed out loudspeaker appears ②.

DISPLAY DEVICE LOCK

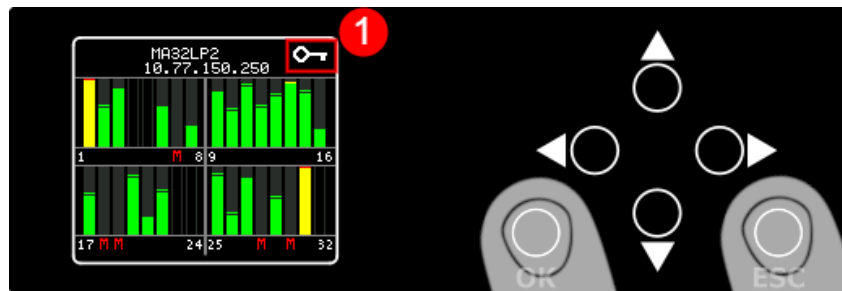

Figure 19. DEVICE LOCK

To enable and disable Display Device Lock, hold **OK** and **ESC** for about 2 seconds. The Device Lock prevents changing the IP settings on display. The small Key ① shows activated Device Lock on every Page.

3.3.2. POWER LED

See ② [FRONT VIEW](#)

Table 6. POWER LED states

COLOR	DESCRIPTION
GREEN	everything is ok
ORANGE	system is booting up
RED	one or more channels are in error state

3.3.3. WEBSITE

To get to the website, open the IP or open the mDNS name. The website is the main User Interface to control every setting and get status informations of the amplifier.



Some DSP function and inputs are optional and depend on the software and hardware options of the device.



In single edit, value fields and buttons with blue background indicate the value is changed but not currently set to the device. In multi-edit it also indicates different values on the selected channel.

HEADER

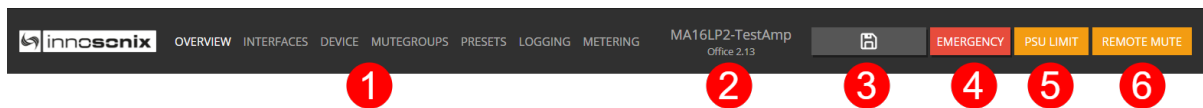

NR	DESCRIPTION	REFERENCE
1	navigate through pages	PAGES
2	click to change hostname or location	
3	save button / autosave status	SAVE INTERNAL STORAGE
4	overall amp status	AMP STATUS
5	PSU Limit indication	PSU LIMIT
6	Remote Mute active indication	DEVICE

PAGES

See [1](#) on [WEBPAGE HEADER](#)

Table 7. PAGES

IDENTIFIER	DESCRIPTION	REFERENCE
OVERVIEW	status and settings of amp channel	OVERVIEW
INTERFACES	device interface status and config	INTERFACES
DEVICE	device specific settings	DEVICE
MUTEGROUPS	mutegroup settings	MUTEGROUPS
PRESETS	device/channel preset edit/save/call/store	PRESETS
LOGGING	syslog with syslog server settings	LOGGING
METERING	show input / output level and measured voltage / current / power	METERING

SAVE INTERNAL STORAGE



After changing a setting, the auto save triggers, so all settings will be saved automatically after ten seconds.

If you click on [WEBPAGE HEADER 3](#), the save process will be triggered manually, so the amplifier saves all current settings to load at the next startup.

PSU LIMIT

If maximum power of the PSU is reached, the amplifier reduces the output with an extra limiter, to avoid shutting down the amplifier. The indicator LED ([WEBPAGE HEADER 5](#)) starts blinking, if reduction is active. To see the actual reduction value and load, see [DEVICE 4](#)

AMP STATUS

The Amp Status shows all currently applicable errors. To see the chronological sequence of errors see [LOGGING](#).

DEVICE AND CHANNEL STATUS				
DEVICE 1				
NAME	STATUS	CODE	TEXT	
MA32LP2	OK			
CHANNEL 2				
CH	NAME	STATUS	CODE	TEXT
1	CH 1	WARNING 3	4	5
		WARNING	29	Speaker no longer detected, check wiring
2	CH 2	WARNING		
		WARNING	29	Speaker no longer detected, check wiring
3	CH 3	WARNING		
		WARNING	29	Speaker no longer detected, check wiring

NR	DESCRIPTION	REFERENCE
1	device errors	
2	channel errors	
3	severity level	SEVERITY LEVEL
4	error code	ERROR CODES
5	error text	

FOOTER

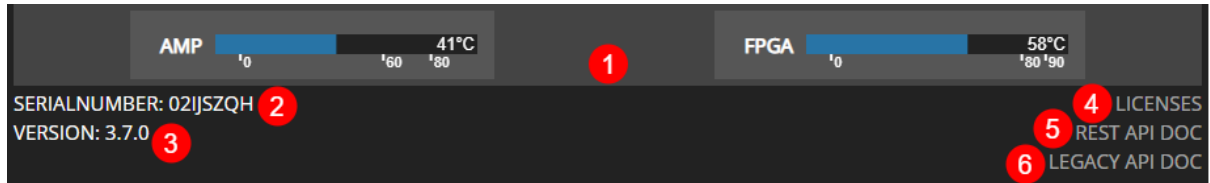

NR	DESCRIPTION	REFERENCE
1	Amp and FPGA temperatures (at 80°C the Amplifier executes emergency shutdown)	
2	device serial number	
3	software version	
4	navigate to license page	
5	navigate to rest api doc	RESTful API
6	navigate to legacy api doc	

OVERVIEW

All channel setting can be done to single and multi-channel (see [SELECTION AND GROUPING](#) for multi-channel selection details).

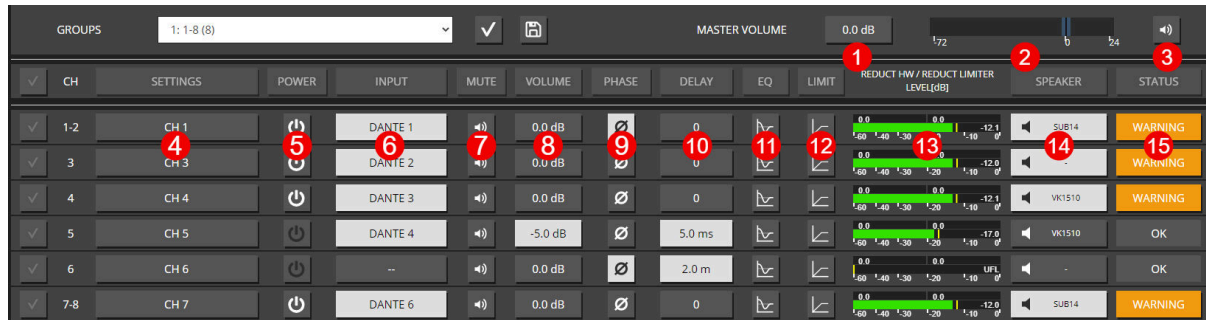

NR	DESCRIPTION	REFERENCE
1	click to set master volume	
2	change master volume by moving the slider	
3	click to toggle master mute	
4	click opens channel settings modal	CHANNEL SETTINGS
5	click to toggle amplifier power	CHANNEL POWER
6	click opens input patching modal (Σ indicates, that multiple inputs are set)	CHANNEL INPUT
7	click to toggle channel mute (blinks if muted by mutegroup MUTEGROUPS)	CHANNEL MUTE
8	click opens channel volume modal	CHANNEL VOLUME
9	click to toggle channel phase (reverses phase)	CHANNEL PHASE
10	click opens channel delay modal	CHANNEL DELAY
11	click opens channel eq modal	CHANNEL EQ
12	click opens channel limiter modal	CHANNEL LIMIT
13	sample synchronous channel level after processing, hw limiter (sum of PSU Limit and Thermo Limit) and biggest limiter reduction	
14	click opens channel speaker settings modal	CHANNEL SPEAKER SETTINGS
15	if error occurs, click opens channel status modal	error shown like AMP STATUS

SELECTION AND GROUPING

Multiple channels can be selected by clicking on . This feature enables the "multi-channel edit" functionality indicated by the active headline buttons (SETTINGS, POWER, ...). The headline buttons open the corresponding modal.



The saved selection groups will be used as mute groups **MUTEGROUPS** and can be selected in the channel edit modal header **MODAL HEADER**.

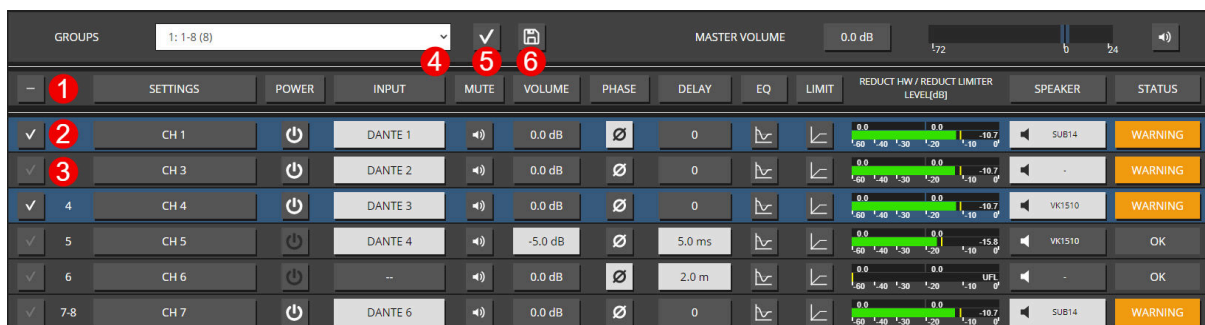
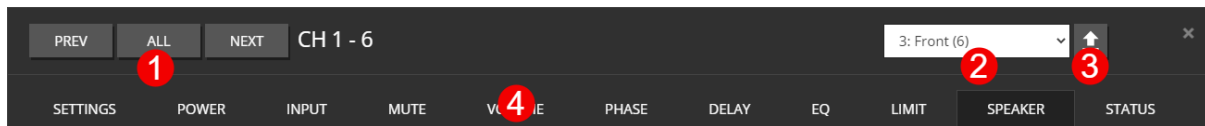

Figure 20. WEBPAGE GROUPING

NR	DESCRIPTION
1	Select/deselect all channels.
2	Channel is selected. Indicators are the white hook and the blue background of the channel line.
3	Channel is not selected.
4	Channel Groups drop-down list.
5	Loads the selected group to the selection.
6	Saves active selection to the selected group.

MODAL HEADER



NR	DESCRIPTION
1	Shows the current selected channels. The "PREV / ALL / NEXT" allows cycling through the selected channels to allow an easy single channel edit.
2	Select a selection group. (see. SELECTION AND GROUPING)
3	Loads the selected group to the selection.
4	Settings for the selected channels.

CHANNEL SETTINGS

CHANNEL NAME

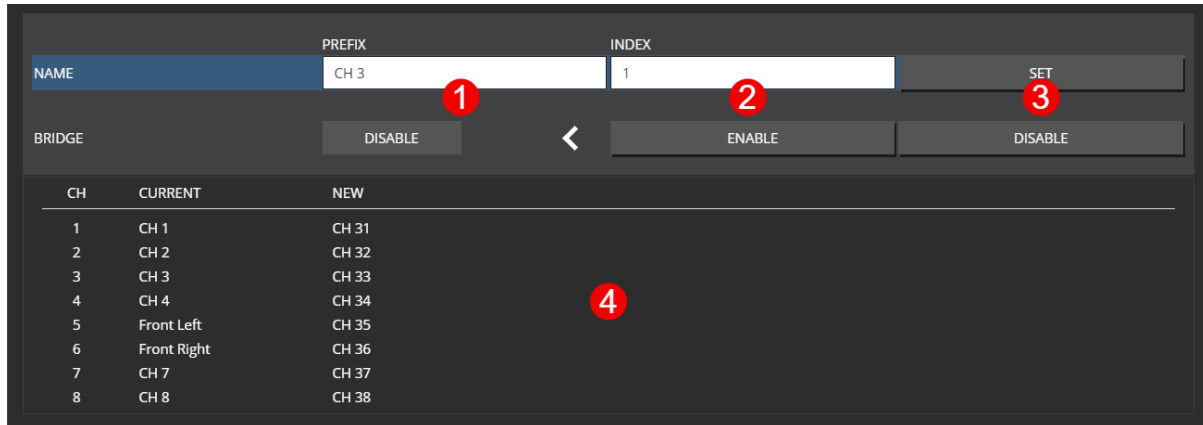

The screenshot shows a software interface for channel settings. At the top, there are two input fields: 'PREFIX' containing 'CH 3' and 'INDEX' containing '1'. To the right of these fields is a 'SET' button. Below the input fields are three buttons: 'DISABLE', 'ENABLE', and 'DISABLE'. A table below these buttons shows a list of channels with columns 'CH', 'CURRENT', and 'NEW'. The table contains 8 rows of channel data. Red callout numbers 1, 2, 3, and 4 are placed over the PREFIX field, INDEX field, SET button, and the table, respectively.

CH	CURRENT	NEW
1	CH 1	CH 31
2	CH 2	CH 32
3	CH 3	CH 33
4	CH 4	CH 34
5	Front Left	CH 35
6	Front Right	CH 36
7	CH 7	CH 37
8	CH 8	CH 38

NR	DESCRIPTION
1	Set channel prefix, which will be concatenated with the "INDEX" as final channel name.
2	Set an optional index which is incremented for each selected channel. (only available in multi-edit)
3	Execute changes.
4	Preview of channel names.

BRIDGE MODE

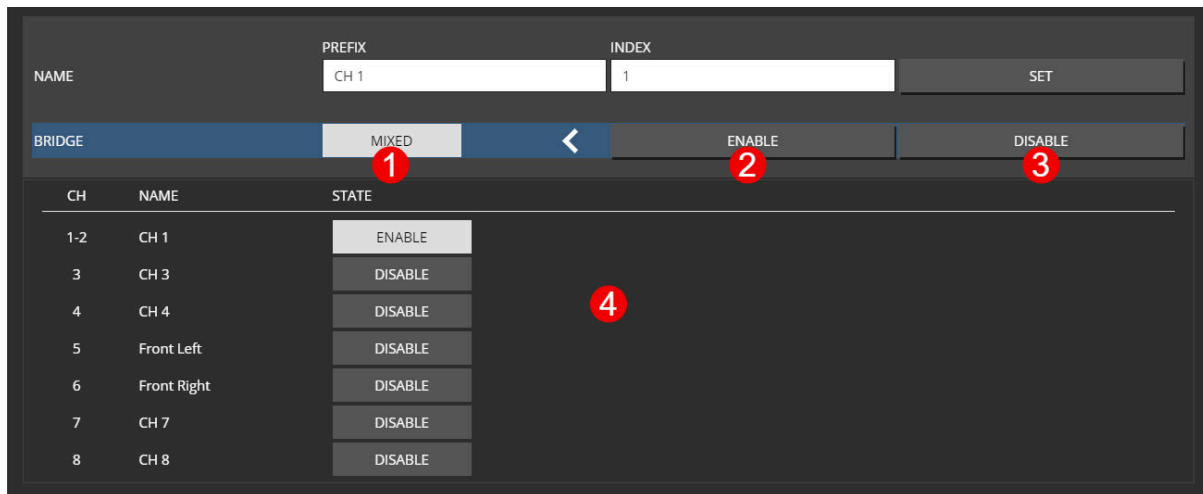

CH	NAME	STATE
1-2	CH 1	ENABLE
3	CH 3	DISABLE
4	CH 4	DISABLE
5	Front Left	DISABLE
6	Front Right	DISABLE
7	CH 7	DISABLE
8	CH 8	DISABLE

NR | DESCRIPTION

1 Indicates summarized state of selected channels.

2 Enable bridge mode for selected channels.

3 Disable bridge mode for selected channels.

4 States for all selected channels.



Only adjacent channel pairs can be set to bridge mode, channel 1/2 or 3/4 ...



Enabling the **BRIDGE MODE** for a channel pair will clear all settings of the EVEN channel.

CHANNEL POWER



Power-off a channel will stop the class-d amp from switching to save idle power.

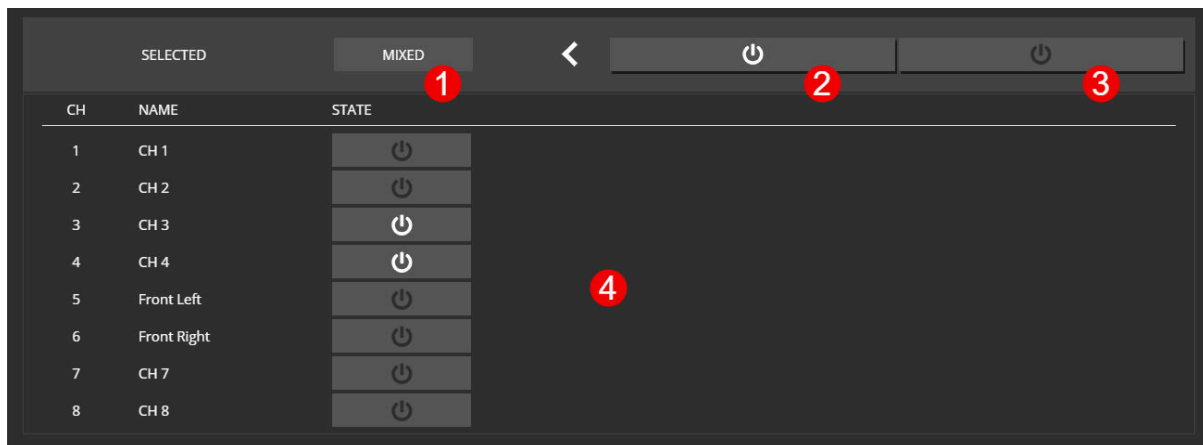

NR	DESCRIPTION
1	Indicates summarized state of selected channel.
2	Activate all selected channels.
3	Deactivate all selected channels.
4	States for all selected channels.

CHANNEL INPUT

Each DSP channel has its own 16x1 input mixer which allows a summation of up to 16 different sources with individual gains.

SINGLE CHANNEL

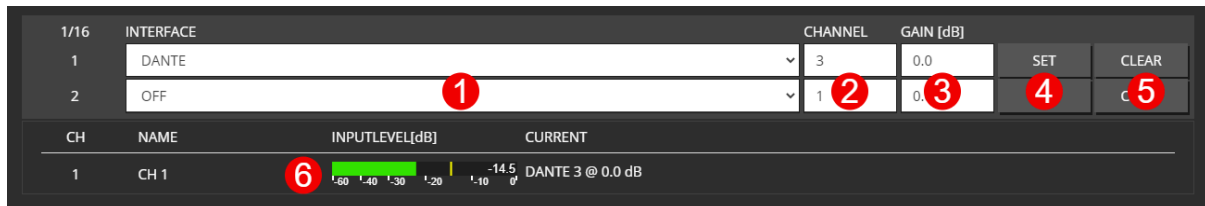

1/16	INTERFACE	CHANNEL	GAIN [dB]	SET	CLEAR
1	DANTE	3	0.0		
2	OFF	1	0.		

CH	NAME	INPUTLEVEL[dB]	CURRENT
1	CH 1	-14.5	DANTE 3 @ 0.0 dB

NR	DESCRIPTION
1	Select a input interface or test tone (depends on your hard- and software-options).
2	Select channel of interface type.
3	Gain for the selected source channel.
4	Sets slected parameters.
5	Remove the patch in the input mixer.
6	Mixer output level.

If you set the last slot, a new input slot appears till the maximum of 16 slots is reached.

MULTI CHANNEL

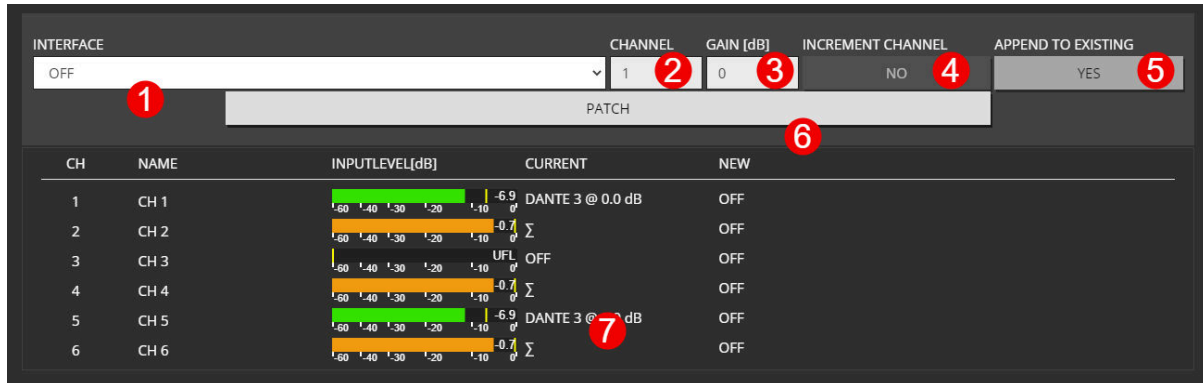

CH	NAME	INPUTLEVEL[dB]	CURRENT	NEW
1	CH 1	-6.9	DANTE 3 @ 0.0 dB	OFF
2	CH 2	-0.7	Σ	OFF
3	CH 3	UFL	OFF	OFF
4	CH 4	-0.7	Σ	OFF
5	CH 5	-6.9	DANTE 3 @ 0.0 dB	OFF
6	CH 6	-0.7	Σ	OFF

NR	DESCRIPTION
1	Select a input interface or test tone (depends on your hard- and software-options).
2	Select channel of interface type.
3	Gain for the selected source channel.
4	Increments input channel through patch.
5	Appends selected patching to existing patches on the channels.
6	Execute the patch command.
7	Preview of selected combination.



Σ indicates, that multiple inputs are set.

CHANNEL MUTE

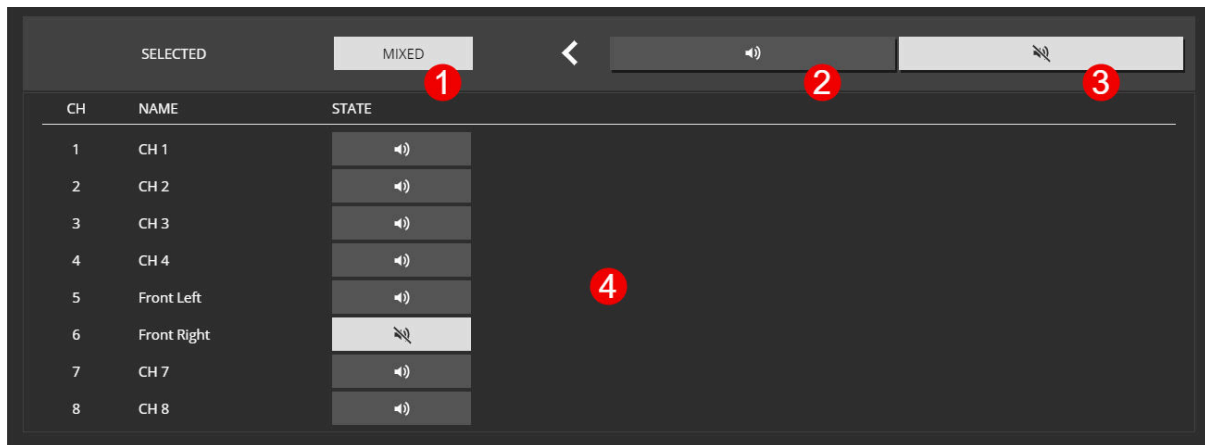

NR	DESCRIPTION
1	Indicates summarized state of selected channels.
2	Unmutes all selected channels.
3	Mutes all selected channels.
4	Shows states of all selected channels.

CHANNEL VOLUME

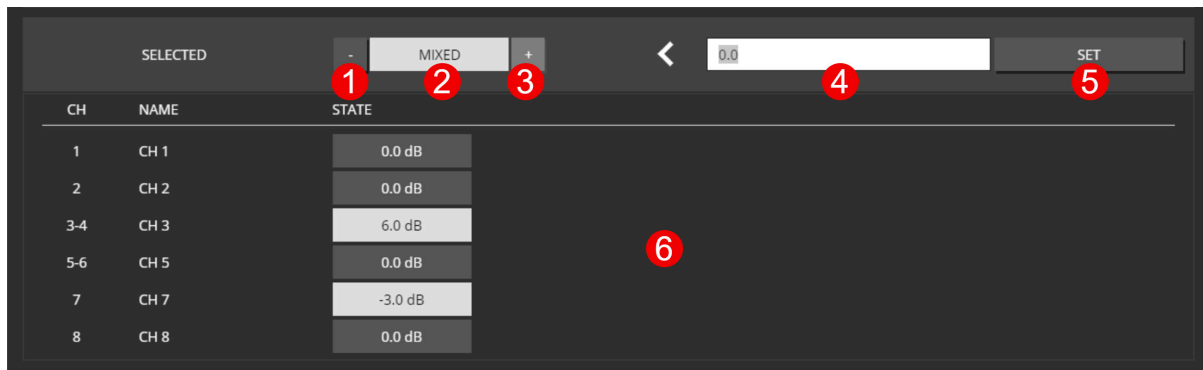

NR	DESCRIPTION
1	Decreases volume of selected channels by 1 dB.
2	Indicates summarized the state of selected channels.
3	Increases volume of selected channels by 1 dB.
4	Channel volume to set.
5	Apply Settings.
6	Shows vales of selected channels.

CHANNEL PHASE

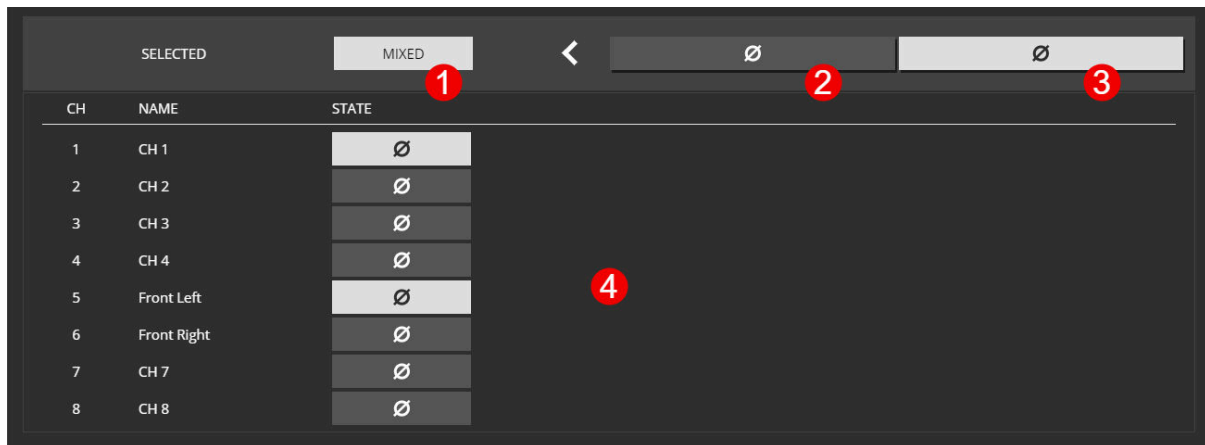

NR	DESCRIPTION
1	Indicates summarized state of selected channels.
2	Set normal phase.
3	Set reverse phase.
4	Shows vales of selected channels.

CHANNEL DELAY

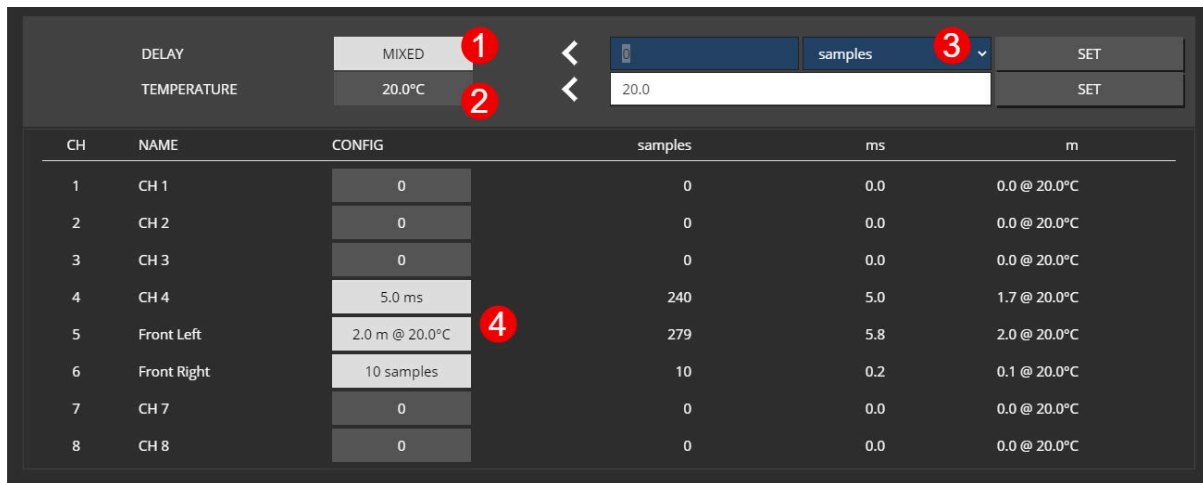

CH	NAME	CONFIG	samples	ms	m
1	CH 1	0	0	0.0	0.0 @ 20.0°C
2	CH 2	0	0	0.0	0.0 @ 20.0°C
3	CH 3	0	0	0.0	0.0 @ 20.0°C
4	CH 4	5.0 ms	240	5.0	1.7 @ 20.0°C
5	Front Left	2.0 m @ 20.0°C	279	5.8	2.0 @ 20.0°C
6	Front Right	10 samples	10	0.2	0.1 @ 20.0°C
7	CH 7	0	0	0.0	0.0 @ 20.0°C
8	CH 8	0	0	0.0	0.0 @ 20.0°C

NR	DESCRIPTION
----	-------------

- | | |
|---|---|
| 1 | Indicates summarized delay of selected channels. |
| 2 | When setting the delay in meters, an air temperature has to be specified to calculate the speed of sound. |
| 3 | Delay can be set in different units, like samples, meters, milliseconds. |
| 4 | Shows vales of selected channels. |



The values for ms and m will be calculated with given temperature and/or samplingrate. The result will be round to samples. 4 show calced value.

CHANNEL EQ

PEQ



There are 32 EQ slots that can be set with several EQ types. Some EQ types need more than one EQ slot. 18dB/24dB Low/High passes require two, while 48dB Low/High require four slots.



When values are changed but not set to the device, the EQ is in preview mode **2**, and the PEQ plot only shows the theoretical EQ curve. The current enabled EQs are plotted in the output curve.



NR	DESCRIPTION
1	Enables fullscreen mode.
2	Toggle visibility of peq sum plot.
3	Toggle visibility of advanced eq plot.
4	Indicates preview mode.
5	Drag the grab point with the mouse to change frequency/gain, use the mouse wheel to change the quality.
6	Switch between the PEQ / ADVANCED EQ settings.
7	Edit / shows the parameter of all EQs.
8	Multi-edit values for all selected channels.

PEQ FULLSCREEN



NR	DESCRIPTION
1	Toggle toolbox view.
2	Edit / shows the parameter of the selected EQ slot.
3	Drag the grab point with the mouse to change frequency/gain, use the mouse wheel to change the quality.

ADVANCED EQ (FIR)

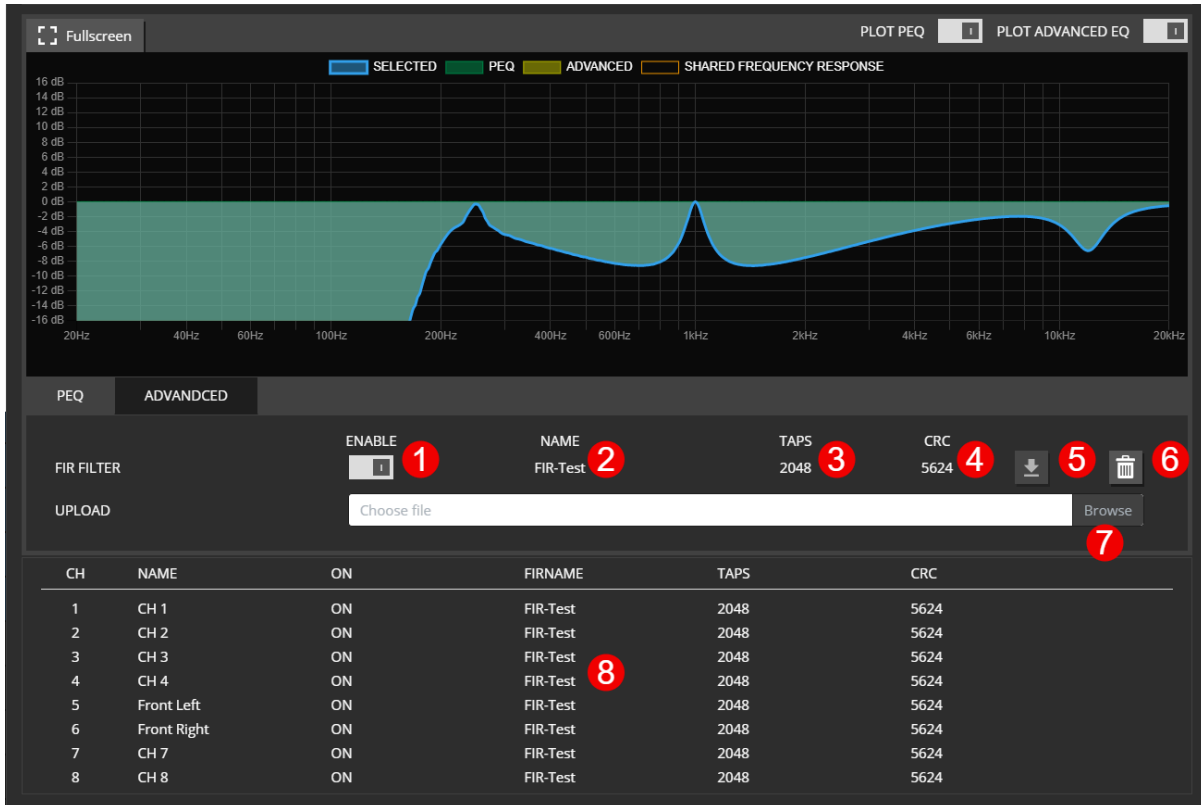

CH	NAME	ON	FIRNAME	TAPS	CRC
1	CH 1	ON	FIR-Test	2048	5624
2	CH 2	ON	FIR-Test	2048	5624
3	CH 3	ON	FIR-Test	2048	5624
4	CH 4	ON	FIR-Test	2048	5624
5	Front Left	ON	FIR-Test	2048	5624
6	Front Right	ON	FIR-Test	2048	5624
7	CH 7	ON	FIR-Test	2048	5624
8	CH 8	ON	FIR-Test	2048	5624

NR	DESCRIPTION
----	-------------

1	Enable/disable the FIR filter on the selected channel.
---	--

2	Name of the loaded FIR filter.
---	--------------------------------

3	Taps of the loaded FIR filter.
---	--------------------------------

4	Internal calculated CRC over the fixed point coefficients to indicate even single bit differences in the loaded filters.
---	--

5	Download the selected FIR (only available on single edit)
---	---

6	Delete FIR filter.
---	--------------------

7	Upload a FIR filter to the selected channels (a preview modal appears to check the filter)
---	--

8	Details of all selected channels.
---	-----------------------------------

CHANNEL LIMIT

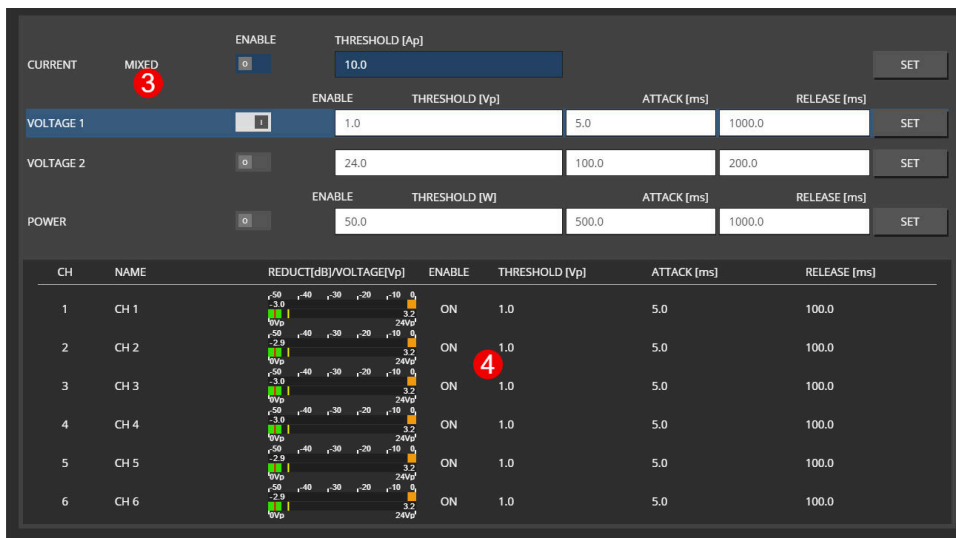
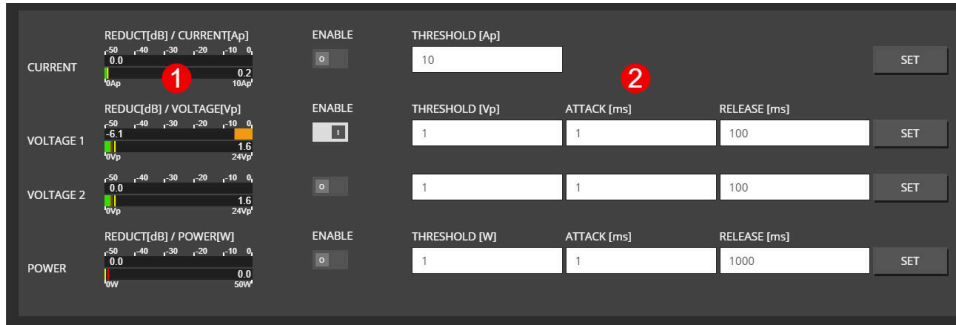

NR DESCRIPTION

- 1 Shows reduction and measured input level (Vp, Ap, or W) of each limiter.
- 2 Set threshold attack and release of individual limiter.
- 3 Reduction level disabled in multi-edit, each limiter can be selected and is highlighted by the blue line.
- 4 Shows limiter values of the selected limiter and selected channels.



Disabled limiters are set to the maximum threshold internally. Due to the internal headroom, it is still possible to see some reduction if the maximum thresholds are reached.

CHANNEL SPEAKER SETTINGS

SINGLE EDIT

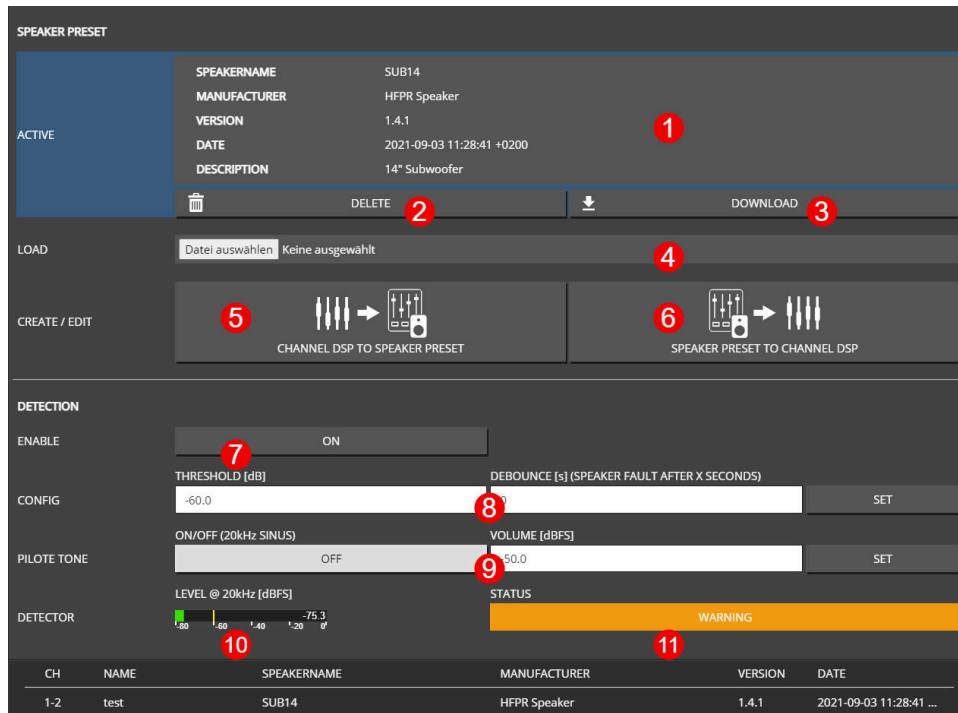

Figure 21. SPEAKER SINGLE CHANNEL EDIT VIEW

NR	DESCRIPTION
1	Metadata of the active speaker preset.
2	Remove the speaker preset.
3	Download the speaker preset file to share it or apply to others channels.
4	Load a speaker preset file from your computer.
5	Create a speaker preset from channel dsp data WEBPAGE SPEAKER PRESET CREATE .
6	Load the speaker preset dsp data to the channel dsp WEBPAGE SPEAKER PRESET LOAD .
7	Enable/Disable speaker detection.
8	Set detection threshold and debounce. The 20 kHz current value has to be lower than the threshold for "debounce" seconds to trigger an error.
9	Set 20 kHz pilot tone generator level in dBFS which will be added to the actual output signal of the amplifier.
10	Shows measured current at 20 kHz (yellow line indicates threshold)
11	Shows actual speaker detection status.

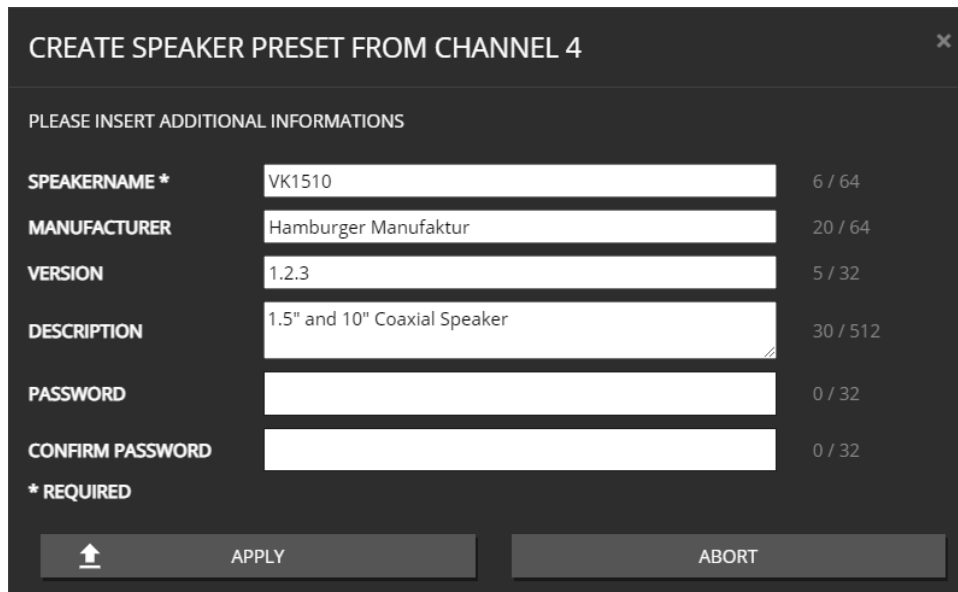

Figure 22. WEBPAGE SPEAKER PRESET CREATE

To create a speaker preset, tune your speaker with the channel DSP settings to your needs. The parameter which can be used inside the speaker preset are: VOLUME, PHASE, DELAY, 32x PEQ, ADVANCED EQ (FIR Filters with 512 Taps), LIMIT.

Once happy with your parameter work, create the speaker preset by clicking on the "CHANNEL DSP TO SPEAKER PRESET" button. This will copy all parameters listed above to a fully separated "SPEAKER DSP" and free up the "CHANNEL DSP".

Information like a speaker name is mandatory, all other parameters are optional. If the data have to be secure, please insert a password. This password is only required to load the speaker preset to the channel DSP (for further editing).



The FIR Filter in the speaker preset can only have 512 taps, instead of the full 2048 taps which are possible in the channel DSP.



The LIMIT section only exists once. If a limiter is used inside a speaker preset, it will just block that specific limiter from being used by the user.

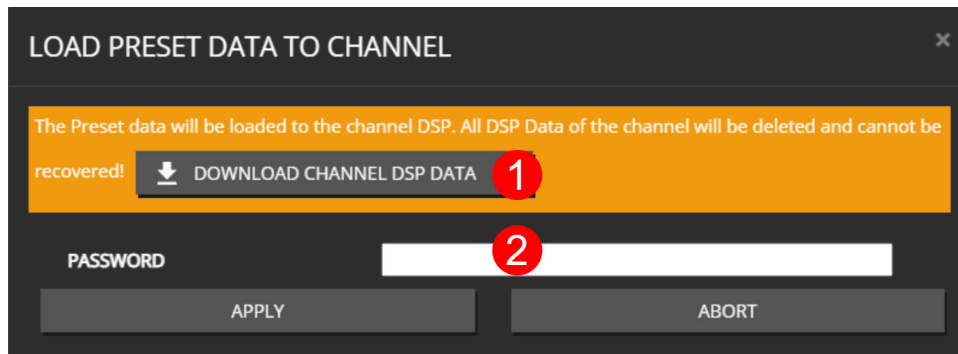

Figure 23. WEBPAGE SPEAKER PRESET LOAD

NR	DESCRIPTION
1	Since the channel DSP will be overwritten by the speaker preset values, a backup of the currently loaded settings can be downloaded as channel preset.
2	If a speaker preset is created with a password, the password is required to load the data to the channel

MULTI EDIT

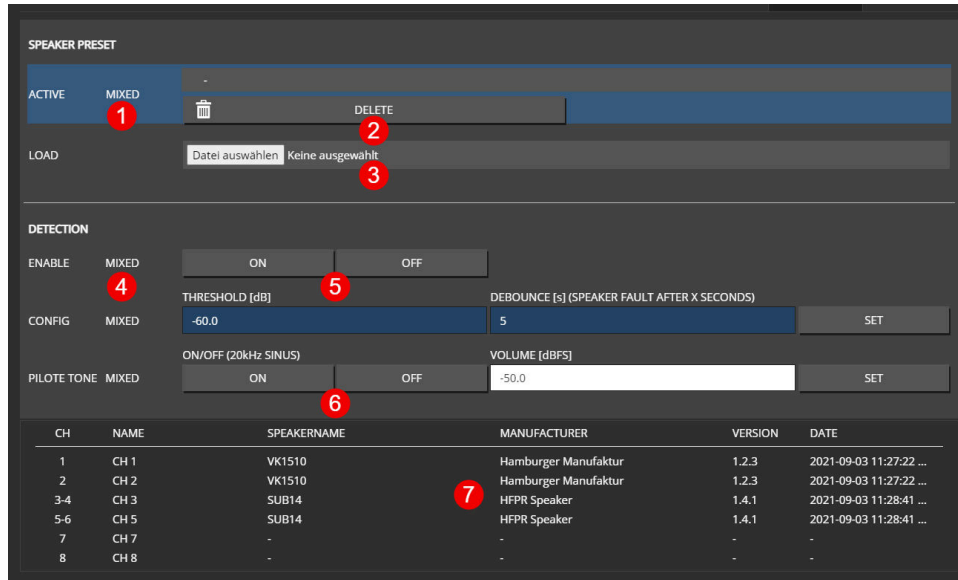

Figure 24. SPEAKER MULTI CHANNEL EDIT VIEW

NR	DESCRIPTION
1	Mixed speaker preset indicator (different speakers presets are loaded on the selected channel)
2	Delete the currently loaded speaker preset from all selected channels.
3	Load a speaker preset file from your computer to all selected channels.
4	Mixed value indicator of the speaker detection section.
5	Enable/Disable speaker detection.
6	Set 20 kHz pilot tone generator level in dBFS which will be added to the actual output signal of the amplifier.
7	Shows actual speaker detection status.

INTERFACES

INTERFACE STATUS				
SYNC SELECT	NAME	STATUS	SAMPLINGRATE	CHANNEL
<input type="radio"/>	MADI FIBRE	unlock	-	-
<input type="radio"/>	MADI COAX 1	unlock	-	-
<input type="radio"/>	MADI COAX 2	unlock	-	-
<input checked="" type="radio"/>	DANTE	sync	48kHz	32
<input type="radio"/>	AES3 1 (ASRC)	unlock	-	-
<input type="radio"/>	AES3 2 (ASRC)	unlock	-	-
DIRECT MADI FIBRE OUTPUT				
INTERNAL TX				
INTERNAL MADI FIBRE/DANTE OUTPUT				
CURRENT OUT (Ch. 1 - 32)				

Figure 25. WEBPAGE INTERFACES

NR	DESCRIPTION
1	Select an interface to synchronize the internal audio word clock generation.
2	Interface name.
3	Interface status see. SYNC STATUS
4	Sampling rate.
5	Available channel on this interface.
6	Select the source of the MADI FIBRE TX jack. This can either be "INTERNAL TX" which uses the internal MADI transmitter, or any of the other MADI RX jacks. In the case of an RX jack, the connection is direct routed through the FPGA with almost zero latency, but a jitter build-up has to be in mind. The direct through connection can be used to daisy-chain two devices to utilize all 64 channels on a MADI signal. Device 1 consumes CH1-32, device 2 CH33-64.
7	Selects a pre-defined output routing of the internal MADI TX / DANTE TX transmitter, see OUTPUT PRESETS .

SYNC STATUS

STATUS	DESCRIPTION
unlock	No valid carrier or word-clock was detected on that interface.
lock	Valid carrier and word-clock but not in phase with the internal audio clock.
sync	Valid carrier and word-clock AND in phase with the internal audio clock.
error	Unsupported sample rate.

OUTPUT PRESETS



Channel assignments on MADI TX and Dante TX are the same.

available Output presets

OFF

MADI FIBRE (Ch. 1 - 64)

MADI FIBRE (Ch. 33 - 64)

MADI COAX 1 (Ch. 1 - 64)

MADI COAX 1 (Ch. 33 - 64)

MADI COAX 2 (Ch. 1 - 64)

MADI COAX 2 (Ch. 33 - 64)

DANTE (Ch. 1 - 32)

DSP OUT (Ch. 1 - 32)

CURRENT OUT (Ch. 1 - 32)

VOLTAGE OUT (Ch. 1 - 32)

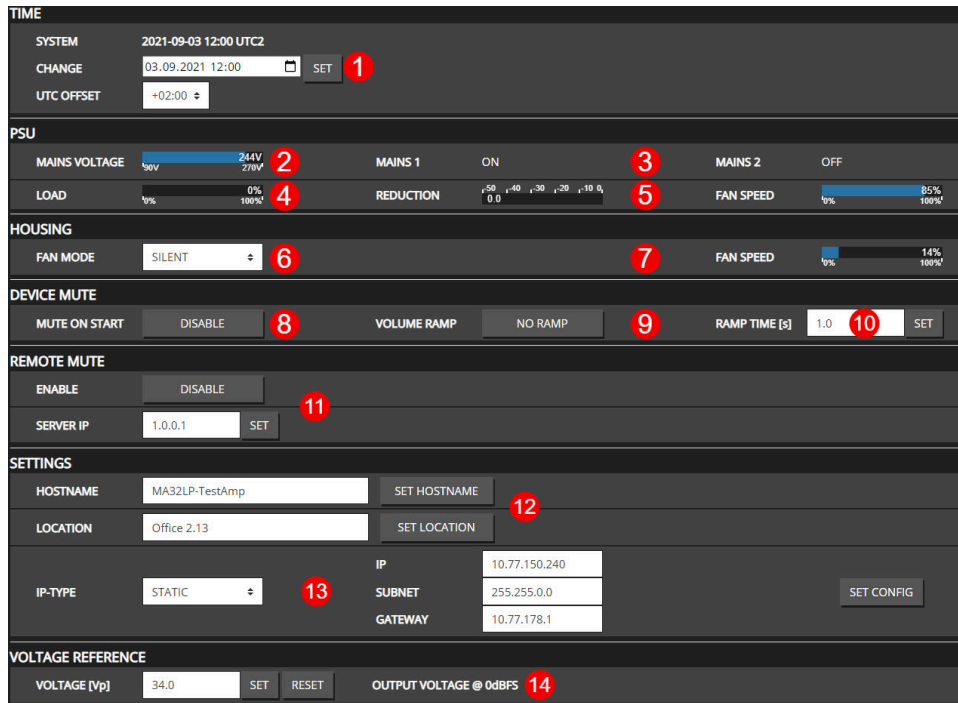
DEVICE

The screenshot shows a web-based configuration interface for a device, organized into several sections. Red circles with numbers 1 through 14 point to specific UI elements:

- 1**: 'CHANGE' button in the TIME section.
- 2**: Mains voltage bar chart in the PSU section.
- 3**: 'MAINS 1' status indicator in the PSU section.
- 4**: Load bar chart in the PSU section.
- 5**: 'REDUCTION' bar chart in the PSU section.
- 6**: 'FAN MODE' dropdown menu in the HOUSING section.
- 7**: 'FAN SPEED' bar chart in the HOUSING section.
- 8**: 'MUTE ON START' dropdown menu in the DEVICE MUTE section.
- 9**: 'VOLUME RAMP' dropdown menu in the DEVICE MUTE section.
- 10**: 'RAMP TIME [s]' input field in the DEVICE MUTE section.
- 11**: 'ENABLE' button in the REMOTE MUTE section.
- 12**: 'SET HOSTNAME' button in the SETTINGS section.
- 13**: 'IP-TYPE' dropdown menu in the SETTINGS section.
- 14**: 'OUTPUT VOLTAGE @ 0dBFS' input field in the VOLTAGE REFERENCE section.

NR	DESCRIPTION
1	Set system time and time zone. If the device is connected to the internet, it will try to synchronize its RTC (real time clock) to an NTP time-server.
2	Shows measured mains voltage if the device does support it. If not, the user has to configure the current mains voltage which is required for the PSU limiting.
3	If the device has more than one PSU, it will indicate which one is plugged in. (HP ² only)
4	Shows PSU Load.
5	Shows PSU reduction, which will reduce the output level of all channels simultaneously to not overload the PSU.
6	FAN MODE "NORMAL" is the recommended mode to keep all components as cool as possible to improve lifetime. When not much output power is required, the FAN MODE could be changed to "SILENT" or "PASSIVE" (LP ² only) which will use different fan speeds to reduce noise.
7	Shows actual housing fan speed (depends on internal temperature).
8	En-/disable mute on startup, if enabled, the "MASTER MUTE" will be set on every start up.
9	En-/disable volume ramp after the master mute is disabled. This will linearly increase the dB value until it is reached its desired value.
10	Master Volume ramp-up-time in seconds, if enabled.
11	Enable remote mute, this will provide a GPI interface to mute the entire device, also known as dead man switch. Which require an external Innosonix Remote Mute Server, multiple devices can share one server.

12

The "HOSTNAME" is used in DNS for IP resolving. "LOCATION" is just a string to add some additional information to the device, like where is it located.

13

Set IP setting, this will disconnect the web page. Manually connect to the new IP or HOSTNAME in your browser.

14

"VOLTAGE REFERENCE" defines the maximal output peak-voltage when feeding an 0dBFS signal on any input interface. Due to different maximum rail voltages based on the hardware device, a clipping could occur.

MUTEGROUPS

Mute groups assignment are derived from selection groups ([SELECTION AND GROUPING](#)).

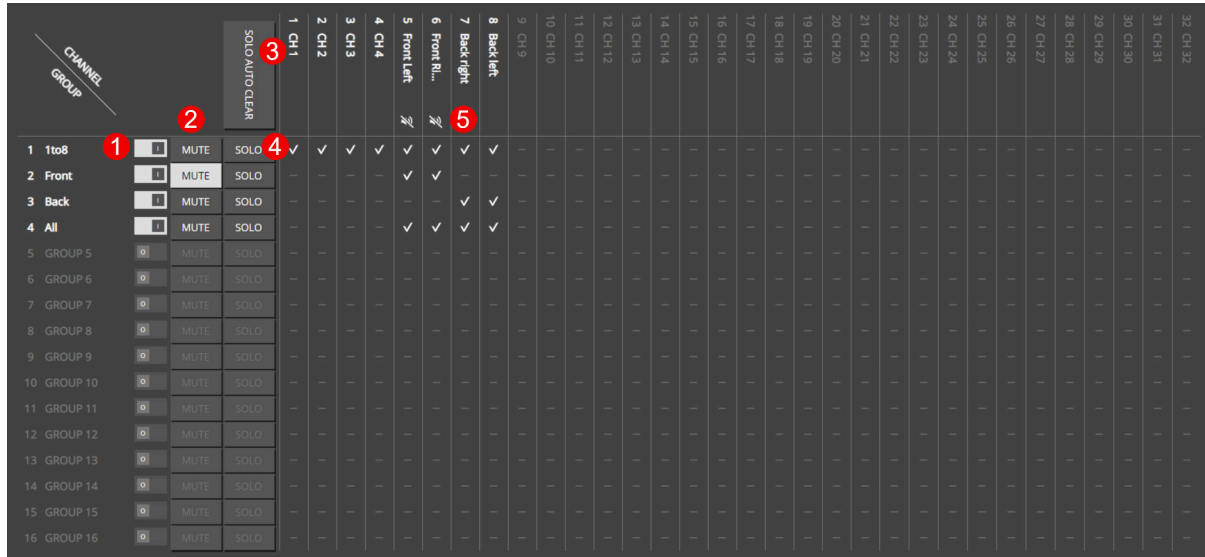

CHANNEL GROUP	MUTE	SOLO	1 CH 1	2 CH 2	3 CH 3	4 CH 4	5 Front Left	6 Front Right	7 Backright	8 Backleft	9 CH 9	10 CH 10	11 CH 11	12 CH 12	13 CH 13	14 CH 14	15 CH 15	16 CH 16	17 CH 17	18 CH 18	19 CH 19	20 CH 20	21 CH 21	22 CH 22	23 CH 23	24 CH 24	25 CH 25	26 CH 26	27 CH 27	28 CH 28	29 CH 29	30 CH 30	31 CH 31	32 CH 32
1 1to8	<input type="checkbox"/>	<input checked="" type="checkbox"/>	<input checked="" type="checkbox"/>	<input checked="" type="checkbox"/>	<input checked="" type="checkbox"/>	<input checked="" type="checkbox"/>	<input checked="" type="checkbox"/>	<input checked="" type="checkbox"/>	<input checked="" type="checkbox"/>	<input checked="" type="checkbox"/>	<input type="checkbox"/>	<input type="checkbox"/>	<input type="checkbox"/>	<input type="checkbox"/>	<input type="checkbox"/>	<input type="checkbox"/>	<input type="checkbox"/>	<input type="checkbox"/>	<input type="checkbox"/>	<input type="checkbox"/>	<input type="checkbox"/>	<input type="checkbox"/>	<input type="checkbox"/>	<input type="checkbox"/>	<input type="checkbox"/>	<input type="checkbox"/>	<input type="checkbox"/>	<input type="checkbox"/>	<input type="checkbox"/>	<input type="checkbox"/>	<input type="checkbox"/>	<input type="checkbox"/>	<input type="checkbox"/>	<input type="checkbox"/>
2 Front	<input type="checkbox"/>	<input type="checkbox"/>	<input type="checkbox"/>	<input type="checkbox"/>	<input type="checkbox"/>	<input type="checkbox"/>	<input type="checkbox"/>	<input type="checkbox"/>	<input type="checkbox"/>	<input type="checkbox"/>	<input type="checkbox"/>	<input type="checkbox"/>	<input type="checkbox"/>	<input type="checkbox"/>	<input type="checkbox"/>	<input type="checkbox"/>	<input type="checkbox"/>	<input type="checkbox"/>	<input type="checkbox"/>	<input type="checkbox"/>	<input type="checkbox"/>	<input type="checkbox"/>	<input type="checkbox"/>	<input type="checkbox"/>	<input type="checkbox"/>	<input type="checkbox"/>	<input type="checkbox"/>	<input type="checkbox"/>	<input type="checkbox"/>	<input type="checkbox"/>	<input type="checkbox"/>	<input type="checkbox"/>	<input type="checkbox"/>	<input type="checkbox"/>
3 Back	<input type="checkbox"/>	<input type="checkbox"/>	<input type="checkbox"/>	<input type="checkbox"/>	<input type="checkbox"/>	<input type="checkbox"/>	<input type="checkbox"/>	<input type="checkbox"/>	<input type="checkbox"/>	<input type="checkbox"/>	<input type="checkbox"/>	<input type="checkbox"/>	<input type="checkbox"/>	<input type="checkbox"/>	<input type="checkbox"/>	<input type="checkbox"/>	<input type="checkbox"/>	<input type="checkbox"/>	<input type="checkbox"/>	<input type="checkbox"/>	<input type="checkbox"/>	<input type="checkbox"/>	<input type="checkbox"/>	<input type="checkbox"/>	<input type="checkbox"/>	<input type="checkbox"/>	<input type="checkbox"/>	<input type="checkbox"/>	<input type="checkbox"/>	<input type="checkbox"/>	<input type="checkbox"/>	<input type="checkbox"/>	<input type="checkbox"/>	<input type="checkbox"/>
4 All	<input type="checkbox"/>	<input type="checkbox"/>	<input type="checkbox"/>	<input type="checkbox"/>	<input type="checkbox"/>	<input type="checkbox"/>	<input type="checkbox"/>	<input type="checkbox"/>	<input type="checkbox"/>	<input type="checkbox"/>	<input type="checkbox"/>	<input type="checkbox"/>	<input type="checkbox"/>	<input type="checkbox"/>	<input type="checkbox"/>	<input type="checkbox"/>	<input type="checkbox"/>	<input type="checkbox"/>	<input type="checkbox"/>	<input type="checkbox"/>	<input type="checkbox"/>	<input type="checkbox"/>	<input type="checkbox"/>	<input type="checkbox"/>	<input type="checkbox"/>	<input type="checkbox"/>	<input type="checkbox"/>	<input type="checkbox"/>	<input type="checkbox"/>	<input type="checkbox"/>	<input type="checkbox"/>	<input type="checkbox"/>	<input type="checkbox"/>	<input type="checkbox"/>
5 GROUP 5	<input type="checkbox"/>	<input type="checkbox"/>	<input type="checkbox"/>	<input type="checkbox"/>	<input type="checkbox"/>	<input type="checkbox"/>	<input type="checkbox"/>	<input type="checkbox"/>	<input type="checkbox"/>	<input type="checkbox"/>	<input type="checkbox"/>	<input type="checkbox"/>	<input type="checkbox"/>	<input type="checkbox"/>	<input type="checkbox"/>	<input type="checkbox"/>	<input type="checkbox"/>	<input type="checkbox"/>	<input type="checkbox"/>	<input type="checkbox"/>	<input type="checkbox"/>	<input type="checkbox"/>	<input type="checkbox"/>	<input type="checkbox"/>	<input type="checkbox"/>	<input type="checkbox"/>	<input type="checkbox"/>	<input type="checkbox"/>	<input type="checkbox"/>	<input type="checkbox"/>	<input type="checkbox"/>	<input type="checkbox"/>	<input type="checkbox"/>	<input type="checkbox"/>
6 GROUP 6	<input type="checkbox"/>	<input type="checkbox"/>	<input type="checkbox"/>	<input type="checkbox"/>	<input type="checkbox"/>	<input type="checkbox"/>	<input type="checkbox"/>	<input type="checkbox"/>	<input type="checkbox"/>	<input type="checkbox"/>	<input type="checkbox"/>	<input type="checkbox"/>	<input type="checkbox"/>	<input type="checkbox"/>	<input type="checkbox"/>	<input type="checkbox"/>	<input type="checkbox"/>	<input type="checkbox"/>	<input type="checkbox"/>	<input type="checkbox"/>	<input type="checkbox"/>	<input type="checkbox"/>	<input type="checkbox"/>	<input type="checkbox"/>	<input type="checkbox"/>	<input type="checkbox"/>	<input type="checkbox"/>	<input type="checkbox"/>	<input type="checkbox"/>	<input type="checkbox"/>	<input type="checkbox"/>	<input type="checkbox"/>	<input type="checkbox"/>	<input type="checkbox"/>
7 GROUP 7	<input type="checkbox"/>	<input type="checkbox"/>	<input type="checkbox"/>	<input type="checkbox"/>	<input type="checkbox"/>	<input type="checkbox"/>	<input type="checkbox"/>	<input type="checkbox"/>	<input type="checkbox"/>	<input type="checkbox"/>	<input type="checkbox"/>	<input type="checkbox"/>	<input type="checkbox"/>	<input type="checkbox"/>	<input type="checkbox"/>	<input type="checkbox"/>	<input type="checkbox"/>	<input type="checkbox"/>	<input type="checkbox"/>	<input type="checkbox"/>	<input type="checkbox"/>	<input type="checkbox"/>	<input type="checkbox"/>	<input type="checkbox"/>	<input type="checkbox"/>	<input type="checkbox"/>	<input type="checkbox"/>	<input type="checkbox"/>	<input type="checkbox"/>	<input type="checkbox"/>	<input type="checkbox"/>	<input type="checkbox"/>	<input type="checkbox"/>	<input type="checkbox"/>
8 GROUP 8	<input type="checkbox"/>	<input type="checkbox"/>	<input type="checkbox"/>	<input type="checkbox"/>	<input type="checkbox"/>	<input type="checkbox"/>	<input type="checkbox"/>	<input type="checkbox"/>	<input type="checkbox"/>	<input type="checkbox"/>	<input type="checkbox"/>	<input type="checkbox"/>	<input type="checkbox"/>	<input type="checkbox"/>	<input type="checkbox"/>	<input type="checkbox"/>	<input type="checkbox"/>	<input type="checkbox"/>	<input type="checkbox"/>	<input type="checkbox"/>	<input type="checkbox"/>	<input type="checkbox"/>	<input type="checkbox"/>	<input type="checkbox"/>	<input type="checkbox"/>	<input type="checkbox"/>	<input type="checkbox"/>	<input type="checkbox"/>	<input type="checkbox"/>	<input type="checkbox"/>	<input type="checkbox"/>	<input type="checkbox"/>	<input type="checkbox"/>	<input type="checkbox"/>
9 GROUP 9	<input type="checkbox"/>	<input type="checkbox"/>	<input type="checkbox"/>	<input type="checkbox"/>	<input type="checkbox"/>	<input type="checkbox"/>	<input type="checkbox"/>	<input type="checkbox"/>	<input type="checkbox"/>	<input type="checkbox"/>	<input type="checkbox"/>	<input type="checkbox"/>	<input type="checkbox"/>	<input type="checkbox"/>	<input type="checkbox"/>	<input type="checkbox"/>	<input type="checkbox"/>	<input type="checkbox"/>	<input type="checkbox"/>	<input type="checkbox"/>	<input type="checkbox"/>	<input type="checkbox"/>	<input type="checkbox"/>	<input type="checkbox"/>	<input type="checkbox"/>	<input type="checkbox"/>	<input type="checkbox"/>	<input type="checkbox"/>	<input type="checkbox"/>	<input type="checkbox"/>	<input type="checkbox"/>	<input type="checkbox"/>	<input type="checkbox"/>	<input type="checkbox"/>
10 GROUP 10	<input type="checkbox"/>	<input type="checkbox"/>	<input type="checkbox"/>	<input type="checkbox"/>	<input type="checkbox"/>	<input type="checkbox"/>	<input type="checkbox"/>	<input type="checkbox"/>	<input type="checkbox"/>	<input type="checkbox"/>	<input type="checkbox"/>	<input type="checkbox"/>	<input type="checkbox"/>	<input type="checkbox"/>	<input type="checkbox"/>	<input type="checkbox"/>	<input type="checkbox"/>	<input type="checkbox"/>	<input type="checkbox"/>	<input type="checkbox"/>	<input type="checkbox"/>	<input type="checkbox"/>	<input type="checkbox"/>	<input type="checkbox"/>	<input type="checkbox"/>	<input type="checkbox"/>	<input type="checkbox"/>	<input type="checkbox"/>	<input type="checkbox"/>	<input type="checkbox"/>	<input type="checkbox"/>	<input type="checkbox"/>	<input type="checkbox"/>	<input type="checkbox"/>
11 GROUP 11	<input type="checkbox"/>	<input type="checkbox"/>	<input type="checkbox"/>	<input type="checkbox"/>	<input type="checkbox"/>	<input type="checkbox"/>	<input type="checkbox"/>	<input type="checkbox"/>	<input type="checkbox"/>	<input type="checkbox"/>	<input type="checkbox"/>	<input type="checkbox"/>	<input type="checkbox"/>	<input type="checkbox"/>	<input type="checkbox"/>	<input type="checkbox"/>	<input type="checkbox"/>	<input type="checkbox"/>	<input type="checkbox"/>	<input type="checkbox"/>	<input type="checkbox"/>	<input type="checkbox"/>	<input type="checkbox"/>	<input type="checkbox"/>	<input type="checkbox"/>	<input type="checkbox"/>	<input type="checkbox"/>	<input type="checkbox"/>	<input type="checkbox"/>	<input type="checkbox"/>	<input type="checkbox"/>	<input type="checkbox"/>	<input type="checkbox"/>	<input type="checkbox"/>
12 GROUP 12	<input type="checkbox"/>	<input type="checkbox"/>	<input type="checkbox"/>	<input type="checkbox"/>	<input type="checkbox"/>	<input type="checkbox"/>	<input type="checkbox"/>	<input type="checkbox"/>	<input type="checkbox"/>	<input type="checkbox"/>	<input type="checkbox"/>	<input type="checkbox"/>	<input type="checkbox"/>	<input type="checkbox"/>	<input type="checkbox"/>	<input type="checkbox"/>	<input type="checkbox"/>	<input type="checkbox"/>	<input type="checkbox"/>	<input type="checkbox"/>	<input type="checkbox"/>	<input type="checkbox"/>	<input type="checkbox"/>	<input type="checkbox"/>	<input type="checkbox"/>	<input type="checkbox"/>	<input type="checkbox"/>	<input type="checkbox"/>	<input type="checkbox"/>	<input type="checkbox"/>	<input type="checkbox"/>	<input type="checkbox"/>	<input type="checkbox"/>	<input type="checkbox"/>
13 GROUP 13	<input type="checkbox"/>	<input type="checkbox"/>	<input type="checkbox"/>	<input type="checkbox"/>	<input type="checkbox"/>	<input type="checkbox"/>	<input type="checkbox"/>	<input type="checkbox"/>	<input type="checkbox"/>	<input type="checkbox"/>	<input type="checkbox"/>	<input type="checkbox"/>	<input type="checkbox"/>	<input type="checkbox"/>	<input type="checkbox"/>	<input type="checkbox"/>	<input type="checkbox"/>	<input type="checkbox"/>	<input type="checkbox"/>	<input type="checkbox"/>	<input type="checkbox"/>	<input type="checkbox"/>	<input type="checkbox"/>	<input type="checkbox"/>	<input type="checkbox"/>	<input type="checkbox"/>	<input type="checkbox"/>	<input type="checkbox"/>	<input type="checkbox"/>	<input type="checkbox"/>	<input type="checkbox"/>	<input type="checkbox"/>	<input type="checkbox"/>	<input type="checkbox"/>
14 GROUP 14	<input type="checkbox"/>	<input type="checkbox"/>	<input type="checkbox"/>	<input type="checkbox"/>	<input type="checkbox"/>	<input type="checkbox"/>	<input type="checkbox"/>	<input type="checkbox"/>	<input type="checkbox"/>	<input type="checkbox"/>	<input type="checkbox"/>	<input type="checkbox"/>	<input type="checkbox"/>	<input type="checkbox"/>	<input type="checkbox"/>	<input type="checkbox"/>	<input type="checkbox"/>	<input type="checkbox"/>	<input type="checkbox"/>	<input type="checkbox"/>	<input type="checkbox"/>	<input type="checkbox"/>	<input type="checkbox"/>	<input type="checkbox"/>	<input type="checkbox"/>	<input type="checkbox"/>	<input type="checkbox"/>	<input type="checkbox"/>	<input type="checkbox"/>	<input type="checkbox"/>	<input type="checkbox"/>	<input type="checkbox"/>	<input type="checkbox"/>	<input type="checkbox"/>
15 GROUP 15	<input type="checkbox"/>	<input type="checkbox"/>	<input type="checkbox"/>	<input type="checkbox"/>	<input type="checkbox"/>	<input type="checkbox"/>	<input type="checkbox"/>	<input type="checkbox"/>	<input type="checkbox"/>	<input type="checkbox"/>	<input type="checkbox"/>	<input type="checkbox"/>	<input type="checkbox"/>	<input type="checkbox"/>	<input type="checkbox"/>	<input type="checkbox"/>	<input type="checkbox"/>	<input type="checkbox"/>	<input type="checkbox"/>	<input type="checkbox"/>	<input type="checkbox"/>	<input type="checkbox"/>	<input type="checkbox"/>	<input type="checkbox"/>	<input type="checkbox"/>	<input type="checkbox"/>	<input type="checkbox"/>	<input type="checkbox"/>	<input type="checkbox"/>	<input type="checkbox"/>	<input type="checkbox"/>	<input type="checkbox"/>	<input type="checkbox"/>	<input type="checkbox"/>
16 GROUP 16	<input type="checkbox"/>	<input type="checkbox"/>	<input type="checkbox"/>	<input type="checkbox"/>	<input type="checkbox"/>	<input type="checkbox"/>	<input type="checkbox"/>	<input type="checkbox"/>	<input type="checkbox"/>	<input type="checkbox"/>	<input type="checkbox"/>	<input type="checkbox"/>	<input type="checkbox"/>	<input type="checkbox"/>	<input type="checkbox"/>	<input type="checkbox"/>	<input type="checkbox"/>	<input type="checkbox"/>	<input type="checkbox"/>	<input type="checkbox"/>	<input type="checkbox"/>	<input type="checkbox"/>	<input type="checkbox"/>	<input type="checkbox"/>	<input type="checkbox"/>	<input type="checkbox"/>	<input type="checkbox"/>	<input type="checkbox"/>	<input type="checkbox"/>	<input type="checkbox"/>	<input type="checkbox"/>	<input type="checkbox"/>	<input type="checkbox"/>	<input type="checkbox"/>

NR	DESCRIPTION
1	Only enabled mute groups are taken into account when the final mute result is calculated.
2	Mute / unmute mute group.
3	If solo auto clear is activated, only one solo can be active.
4	Active SOLO for the corresponding group. All other channels in an active mute group will be muted.
5	A speaker symbol and blinking MUTE button on the OVERVIEW indicates that the channel is muted due to a mute group assignment.

PRESETS

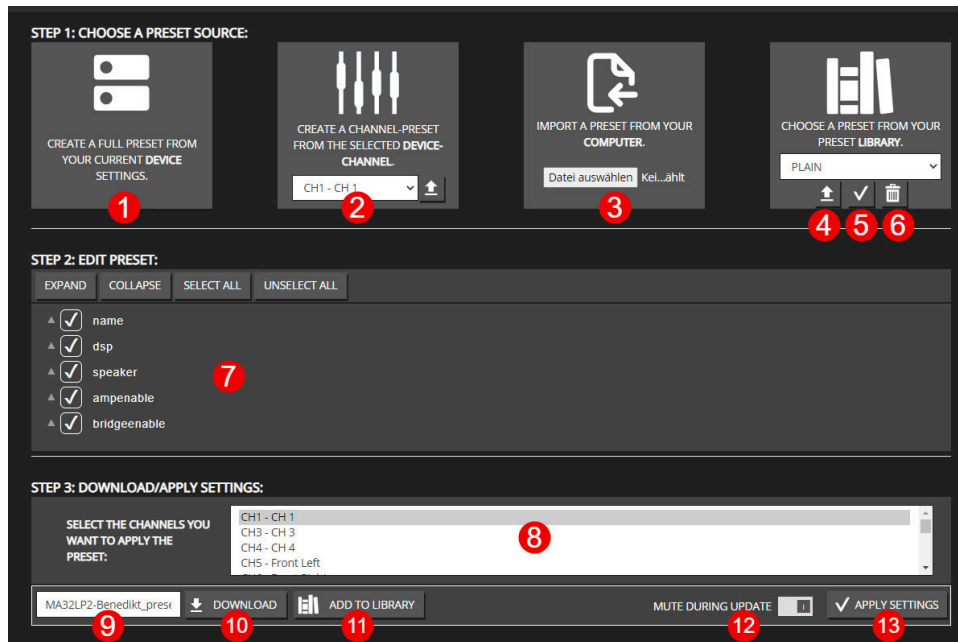

NR	DESCRIPTION
1	Load all device settings to the preset editor (7). Device presets do include fixed mapping of parameters to specific channels.
2	Load setting from one specific channel to preset editor (7).
3	Upload a file from your computer to the editor (7). It can either be a channel or device preset.
4	Load preset from preset library in preset editor (7).
5	Recall the selected preset from the library to the device. This functionality can also easily be triggered via the RESTful-API to do a simple scene switch.
6	Delete selected preset from the library.
7	edit settings tree
8	select (multiple) channel to load preset to (only available if channel preset is loaded into the preset editor)
9	preset name to save in library or download
10	save selected settings as preset to library
11	download selected settings as preset file
12	mute device / channel during update settings from preset
13	apply selected settings to device

LOGGING

SYSLOG











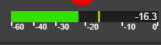

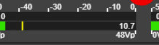

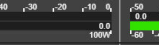
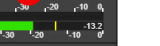

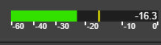
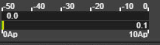
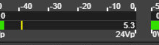
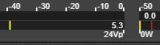
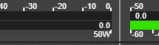
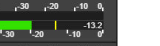

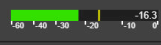

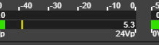

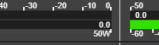
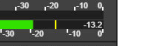
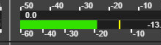

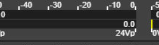
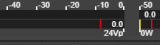
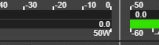
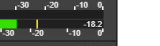

NUMBER LINES REFRESH EXPORT CLEAR SYSLOG

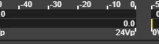
TIME (YYYY-MM-DD hh:mm:ss)	SEVERITY	CATEGORY	MESSAGE
2021-03-30 17:26:51	warning	Channel 01 - CH 1	29 - Speaker no longer detected, check wiring
2021-03-30 17:26:48	informational	Device	01 - Power on with firmware: 3.3.2-16-g6f7b16f
2021-03-30 17:26:45	warning	Channel 03 - CH 3	29 - Speaker no longer detected, check wiring
2021-03-30 17:26:45	warning	Channel 02 - CH 2	29 - Speaker no longer detected, check wiring

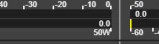
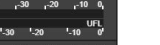
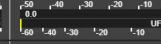
REMOTE SYSLOG CONFIG

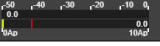
NR	DESCRIPTION
1	select syslog lines to load
2	refresh syslog table
3	export complete syslog from device
4	delete syslog files on the device
5	chronological errors
6	config connection to external syslog server

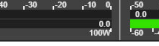
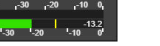
METERING

CH	NAME	INPUT	CURRENT	VOLTAGE 1	LIMITER	VOLTAGE 2	POWER	REDUCTION HARDWARE OUTPUT
1-2	CH 1							
3	CH 3							
4	CH 4							
5	CH 5							
6	CH 6							
7-8	CH 7							

NR	DESCRIPTION
1	input level after input mixer
2	measured current, voltage and power with limiter reductions
3	output level with hardware reduction (sum of PSU Limit and Thermo Limit)

3.3.4. ERROR CODES

Table 8. SEVERITY LEVEL

TYPE	DESCRIPTION
EMERGENCY	system is unusable
ALERT	action must be taken immediately
CRITICAL	critical conditions
ERROR	error conditions
WARNING	warning conditions
NOTICE	normal but significant condition
INFO	informational

Table 9. ERROR CODES

NR	SEVERITY	DESCRIPTION
1	INFO	Power on
2	INFO	IP mode set to DHCP
3	INFO	IP mode set to AUTO IP
4	INFO	IP mode set to STATIC IP
5	ALERT	UDP Discovery error, device no longer available, please try to restart the device
6	INFO	device reboots for software update
7	ALERT	Interfaces monitoring and control no longer available, please try to restart the device
8	ALERT	Speaker monitoring no longer available, please try to restart the device
9	ERROR	Display Interface no longer available, please try to restart the device
10	INFO	Samplingrate changed, EQs, Limiter, FIR Filter will be recalced
11	ALERT	DSP monitoring/control no longer available, please try to restart the device
12	EMERGENCY,	Hardware verification failed, no Audio available
13	ERROR	Metering no longer available, please try to restart the device
14	ERROR	Amplifier overcurrent error
15	ALERT	Amplifier overcurrent Shutdown
16	ALERT	Amplifier recurring overcurrent error, check wiring and powercycle channel to try again
17	EMERGENCY	Amplifier communication error, please try to restart the device
18	WARNING	Amplifier overtemp
19	ALERT	Controller monitoring no longer available, please try to restart the device

NR	SEVERITY	DESCRIPTION
20	ALERT	FAN controller no longer available, please try to restart the device
21	CRITICAL	Overtemp emergency shutdown init, all Fans will turn up, till temperature out of critical range
22	ALERT	PSU monitoring no longer available, please try to restart the device
23	ERROR	No settings file available ⇒ using default settings
24	ERROR	Settings file corrupted, file will be deleted
25	ALERT	All Settings files corrupted, start with default settings
26	ALERT	User Settings cannot be saved anymore, please try to restart the device
27	ALERT	User Settings cannot be changed anymore, please try to restart the device
28	ALERT	User Settings cannot be restored correctly, please try to restart the device
29	WARNING	Speaker no longer detected, check wiring
30	EMERGENCY	Wrong PD Type installed
31	ERROR	No Calibration File available, Amp using default values
32	CRITICAL	Power distribution overcurrent, try to restart
33	EMERGENCY	Amp Module Hardware Error
34	EMERGENCY	Amplifier Shutdown caused by PSU Overcurrent
35	ALERT	Remote Mute no longer available, please try to restart the device
36	EMERGENCY	Start without initing all Amps
37	ALERT	DC not OK
38	EMERGENCY	Amplifier Shutdown caused by overtemp emergency shutdown
39	EMERGENCY	Power Distribution cannot be load, please try to restart the device
40	WARNING	Link unlock
41	WARNING	CRC errors
42	WARNING	Negative Rail Converter ready timeout
43	WARNING	Fan dirty or stuck, check logging for further informations
44	WARNING	Fan dirty, please clean Fan
45	ALERT	Fan stuck, please check Fan
46	EMERGENCY	Amplifier Shutdown caused by dc protection
47	CRITICAL	Amplifier Shutdown caused by overtemperature
48	WARNING	Switching Frequency Error (Channel will be restarted)
49	EMERGENCY	PSU Shutdown caused by dc protection
50	ERROR	DC Detection not ok, syslog no longer prevented
51	ERROR	Mains Dropout Detection not ok, syslog no longer prevented

3.3.5. RESTful API

There is a RESTful API with JSON data implemented on the device. Every Parameter can be set, and every status can be read over this Interface. All available commands are documented at [REST API DOC](#) on the webpage.

The Base URL is: **`$(HOST_IP)/rest-api/`**.

Table 10. REST API HTTP REQUEST TYPES

TYPE	DESCRIPTION
GET	Get settings or status data
PUT	Set device/channel settings
OPTIONS	Get settings value range and unit
DELETE	Delete resource from device



For **PUT** and **DELETE** HTTP requests, an authentication TOKE in the HTTP header is required:

```
token:f4005bf8507999192162d989d5a60823
```

The command line tool **curl** can be used to execute a rest api request which allows some easy evaluation and debugging mechanism.

See some examples below.

GET DEVICE INFORMATION

COMMAND	info/device
TYPE	GET
CURL-COMMAND	curl \${HOST_IP}/rest-api/info/device
RESPONSE	

```
{
  "model_name": "MA32LP2",
  "channel": 32,
  "options": ["D1", "D2", "IF1", "M1", "IF3"],
  "psu_fan": true,
  "housing_fan": true,
  "sd_card": true,
  "rtc": true,
  "sw_revision": "3.3.0",
  "fpga_revision": "2.9.1",
  "loader_revision": "2.1.4",
  "image_id": 1,
  "serial": "140619000221"
}
```

SET CHANNEL MUTE

COMMAND	settings/channel/{channel_id}/dsp/mute
TYPE	PUT
CURL-COMMAND	curl -X PUT -H 'token: f4005bf8507999192162d989d5a60823' -d '{"value":true}' \${HOST_IP}/rest-api/settings/channel/1/dsp/mute

On Success, the server responded with a **200** response.

On Error, the server returns a error message with a **400** response.

GET CHANNEL VOLUME OPTIONS

COMMAND	settings/channel/{channel_id}/dsp/volume
TYPE	OPTIONS
CURL-COMMAND	curl -X OPTIONS \${HOST_IP}/rest-api/settings/channel/1/dsp/volume
RESPONSE	

```
{
  "value": [-72.0, 24.0, 0.1, "dB"]
}
```

```
{
  "value": [MIN, MAX, STEP, UNIT]
}
```

REMOVE PRESET WITH NAME TEST

COMMAND	preset/storage/{preset_name}
TYPE	DELETE
CURL-COMMAND	curl -X OPTIONS \${HOST_IP}/rest-api/preset/storage/test

On Success, the server responded with a **200** response.

On Error, the server returns a error message with a **400** response. .DELETE error example

```
{
  "error": "preset not available: test"
}
```

Chapter 4. DISPOSING

Electrical and electronic equipment must be disposed of separately from normal waste at the end of its operational lifetime. Please dispose of this product according to the respective national regulations or contractual agreements. If there are any further questions concerning the disposal of this product, please contact the manufacturer.

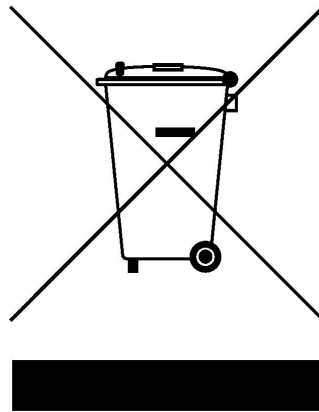

Chapter 5. SERVICE



CAUTION - THESE SERVICING INSTRUCTIONS ARE FOR USE BY QUALIFIED SERVICE PERSONNEL ONLY. TO REDUCE THE RISK OF ELECTRIC SHOCK DO NOT PERFORM ANY SERVICING OTHER THAN THAT CONTAINED IN THE OPERATING INSTRUCTIONS UNLESS YOU ARE QUALIFIED TO DO SO.

ATTENTION - CES CONSIGNES D'ENTRETIEN DOIVENT ETRE UNIQUEMENT EMPLOYES PAR LE PERSONNEL DE SERVICE QUALIFIÉ. POUR RÉDUIRE LE RISQUE DE CHOC ÉLECTRIQUE NE PAS EFFECTUER DES REPARATIONS AUTRES QUE CEUX CONTENUS DANS LES INSTRUCTIONS D'UTILISATION A MOINS QUE VOUS SOYEZ QUALIFIE POUR LE FAIRE

5.1. FUSES

The devices contains internal fuses which are inaccessible to ordinary and instructed persons.

5.2. FIRMWARE UPDATE

It is recommended to update the software to the latest version. To keep the software up to date, see [FIRMWARE UPDATE](#).

5.3. FILTER CLEANING

See ⑤ [MA32D2 BACK VIEW](#)

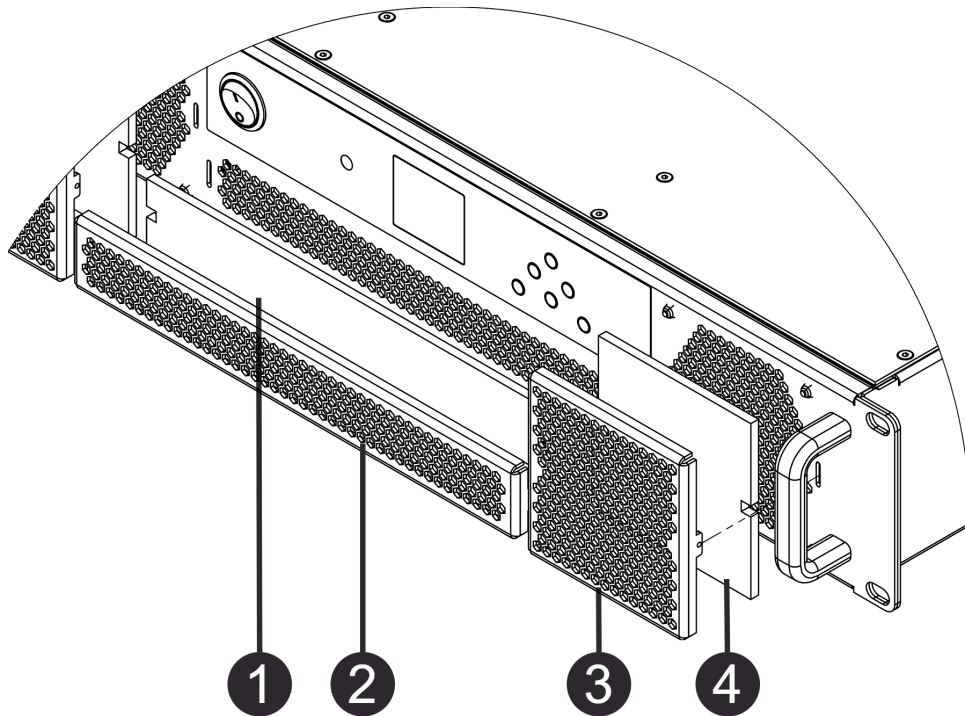

Figure 26. MAXX/D² filter cleaning / replacement

Please clean the filter when dirty. Depending on the installation environment, a regular check is highly recommended.

Remove the grills ② / ③ by gently pulling on it, it is attached with magnets, no tools required. Clean the filters ① / ④ with compressed air and put it back together.

5.4. SPARE PARTS

Table 11. SPARE PARTS

INNOSONIX PART NUMBER	DESCRIPTION	REFERENCE
12578	2-Pol Speaker Connector	CONNECTIONS & CABLE
12572	air filter foam 79x79mm	FILTER CLEANING
12573	air filter foam 227x29mm	FILTER CLEANING
13115	fan grill 230x32mm	FILTER CLEANING
13116	fan grill 82x82mm	FILTER CLEANING
13356	power cord C19 Typ E/F 2m (IEC-LOCK C19 to 3-pin Schuko CEE 7/7)	AVAILABLE POWER CORDS
13358	power cord C19 Typ G 2m (IEC-LOCK C19 to 3-pin GB BS 1363A)	AVAILABLE POWER CORDS

Chapter 6. EU Declaration of Conformity

The company Innosonix GmbH declares under sole responsibility that the products **MA16/D²**, **MA24/D²** and **MA32/D²** complies with the following directives and standards

- EMC Directive **2014/30/EU**
- Low Voltage Directive **2014/35/EU**
- RoHS Directive **2011/65/EU**

6.1. EN 55032:2012

Electromagnetic compatibility of multimedia equipment - **Emission requirements:**

Radiated, Conducted: Class A Limits

6.2. EN 55103-2

EMC Compatibility – Product Family Standard for Audio, Video, Audio-Visual and Entertainment Lighting Control Apparatus for Professional Use, Part 2: **Immunity * EN 61000-4-2:2008 Ed 2.0**

EMC Compatibility – Product Family Standard for Audio, Video, Audio-Visual and Entertainment Lighting Control Apparatus for Professional Use, Part 2: **Immunity * EN 61000-4-3:2010 Ed 3.2**

Radiated, Radio-Frequency, Electromagnetic Immunity (Environment E3, criteria B) * **EN 61000-4-4:2007**

Radiated, Radio-Frequency, EMC Immunity (Environment E3, Criteria B) * **EN 61000-4-5:2006**

Surge Immunity (Criteria B) * **EN 61000-4-6:2006**

Immunity to Conducted Disturbances Induced by Radio-Frequency Fields (Criteria A) * **EN 61000-4-11:2004**

Voltage Dips, Short Interruptions and Voltage Variation

6.3. EN 62368-1:2014/AC:2015

Audio/video, information and communication technology equipment **Part 1: Safety requirements**

6.4. MANUFACTURER

Innosonix GmbH

Hauptstraße 35

D - 96482 Ahorn



Chapter 7. FCC Declaration of Conformity

This equipment has been tested and found to comply with the limits for a Class A digital device, pursuant to Part 15 of the FCC Rules. These limits are designed to provide reasonable protection against harmful interference when the equipment is operated in a commercial environment. This equipment generates, uses, and can radiate radio frequency energy and, if not installed and used in accordance with the instruction manual, may cause harmful interference to radio communications. Operation of this equipment in a residential area is likely to cause harmful interference in which case the user will be required to correct the interference at his own expense.

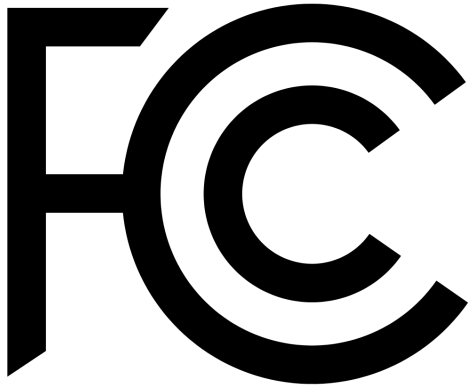



Address : innosonix GmbH
 Hauptstr. 35
 D-96482 Ahorn (Germany)
Phone : +49 (0) 9561 74599-80
Telefax : +49 (0) 9561 74599-89
E-Mail : info@innosonix.de

innosonix GmbH
Executive board: Markus Bätz, Steffen Bätz
USt.-IdNr.: DE 266020313
HRB 5192 Coburg
WEEE-Reg.-Nr. DE 88021242

You can find us on:
www.innosonix.de
www.facebook.com/innosonix.gmbh
www.instagram.com/innosonix.gmbh